

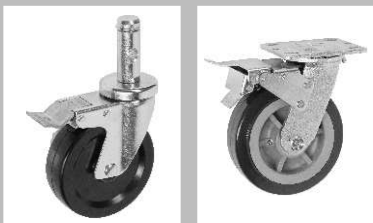

Trio Pines

CASTERS



PRODUCT SERVICE

V.19
CATALOG

“A caster is not just a wheel, it’s a machine”

A machine by textbook definition is an apparatus having several parts, each with a definite function when used together perform a particular task.

At Trio Pines, our casters do just that and more. An integral component bearing its responsibilities of weight, function, and efficiency to operate under any condition or surface is what Trio Pines pledges to deliver to customers one caster at a time.

The Trio Pines difference is in the name.

While a wheel just spins, Trio Pines casters swivel-turn-roll and provide customized mobility to meet the needs of our customers. Each caster wheel undergoes stringent thought design, comprehensive function analysis, and extensive quality assurance paired with spec and tolerance testing for consistent and uniform performance. These disciplines when combined not only create a high quality caster wheel that will do the job, but it will continue to perform delivering sustainable safety, reliability, and cost efficiency for the long haul from any of our multiple regional warehouses.

Known for decades of ingenuity and innovation, the Trio Pines distinguished R&D teams prides themselves on creating custom solutions not only to meet the needs of our customers, but to exceed them. Customers are assured to conveniently find the perfect caster for their mobility needs on any surface including hardwood, asphalt, concrete, tile, brick, metal and the list goes on . . . There’s only one caster wheel that does it all, that’s the Trio Pines difference.

CASTER TERMS

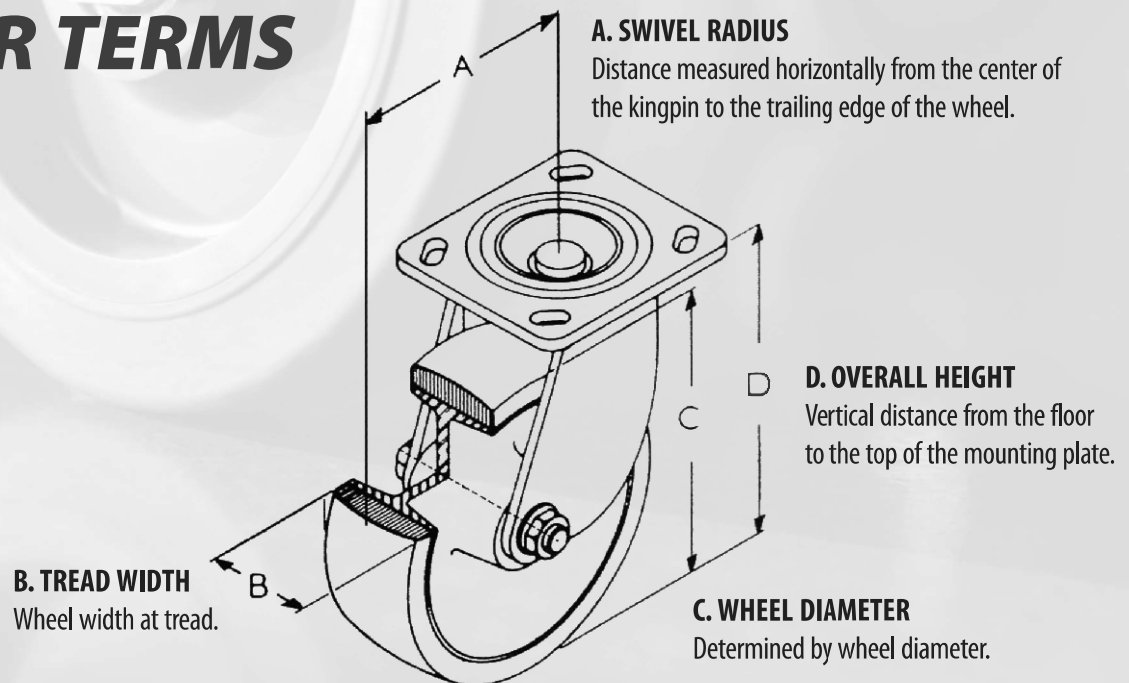



For over 40 years, Trio Pines (USA), Inc. has been recognized as a pioneer in manufacturing superior quality casters while mandating to provide customers with exceptional value, unsurpassed quality, and outstanding customer service.

Founded in 1971 just outside of Seoul, Korea, the principals of Trio Pines set out to become a leading manufacturer of casters and by 1979 they grew the company to be the largest U.S. supplier of casters maintaining the highest integrity of the finest quality products sold anywhere. Thriving on cutting edge technology and innovation as its key strengths, Trio Pines expanded with a vast range of models and varying load capacities from 75 lbs. to 5,400 lbs. appealing any customer's need.

Currently, Trio Pines facilitates production in Seoul, Korea under ISO 9001:2015 and ISO 14001:2015 certification and will expand its manufacturing base into China integrating its proprietary engineering, tooling, and QC assets in effort to uphold its highly reputable brand while delivering the best possible value to its customers as part of its mission.

Trio Pines Casters are world renown having markets in Canada, Mexico, Europe, Latin America, and the Pacific Rim. In North America, there are three warehouses strategically located in Los Angeles, Chicago and Dallas offering nationwide coverage for its valued distributor and OEM channel partners.

One of Trio Pines greatest attributes in addition to its high quality is its limitless versatility which can be applied to hundreds of industries that include food service, healthcare, electronics, computer and medical equipment, heavy duty industrial products, moving dollies, shopping carts, musical equipment, display and garment racks, furniture, and countless other products made and sold in North America. Additionally, most of Trio Pines models are NSF certified to meet safety and sanitary standards.

As market demands change and competitive landscapes grow, Trio Pines will continue to grow its legacy of success with its long standing and time tested history of being a mobility solutions expert in the material handling industry while delivering on its commitment of service excellence to all its existing and new customers at a value.



Numbering System

TP5040-01-MIR-

Series Number

Wheel Diameter

Fastening Type

Wheel Type

Options

20 = 2"
25 = 2-1/2"
30 = 3"
35 = 3-1/2"
40 = 4"
50 = 5"
60 = 6"
80 = 8"
10 = 10"
12 = 12"

0- = Top Plate
1- = Grip Ring Stem
2* = Threaded Stem
3* = Round Stem
4* = Octagon Stem
5* = Square Stem
6- = Grip Neck Stem
(furniture casters)

SR = Soft Rubber
SRB = Soft Rubber with ball bearing
HR = Hard Rubber
HRB = Hard Rubber with ball bearing
MIR = Rubber Tread Plastic Center
RAL = Rubber Tread Aluminum Center
RCI = Rubber Tread Cast Iron Center
PLY = Polyurethane Tread Plastic Center
PCI = Polyurethane Tread Cast Iron Center
STL = Steel
PHN = Phenolic
LDP = Light Duty Plastic
HDP = Heavy Duty Plastic
HPB = Heavy Duty Plastic with ball bearing
HPR = Heavy Duty Plastic with roller bearing
RSD = Rubber Tread Steel Disc Center
PRO = Pro-Tech Polyurethane
VGR = V-Groove Steel
RNY = Rubber Tread Nylon
PRX = Pro-Tech Patriot
PLE = High Elastic Polyurethane

BRAKE TYPE
TLB = Top Lock Brake
SLB = Side Lock Brake
FLB = Front Lock Brake
SWB = Swivel & Wheel Brake

BEARING TYPE
CB = Precision
PBB = Precision
DB = Delring Bearing

WHEEL COLOR
R/B = Red/Black
R/S = Red/Silver
D/B = Dark Blue
B/G = Blue Green

OTHERS
P/TG = Plastic TG
M/TG = Metal TG



Multiple TrioPines Casters are NSF Listed.
Please call (800) 468-6987 for information,
or visit www.NSF.org



FASTENING TYPE

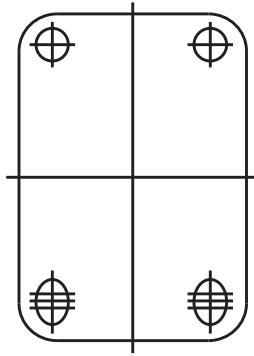

0* = Top Plate

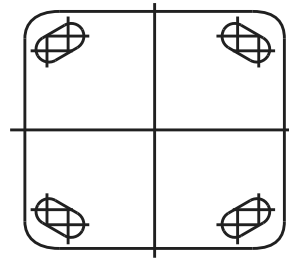

0* = Slot Hole Spacing

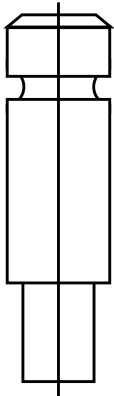

1* = Grip Ring Stem

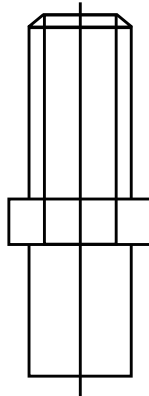

2* = Threaded Stem

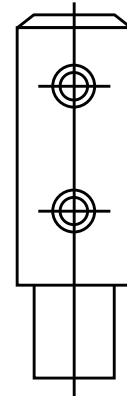

3* = Round Stem

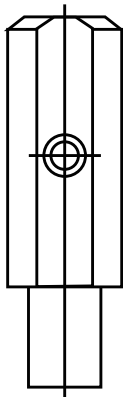

4* = Octagon Stem

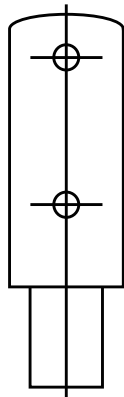

5* = Square Stem

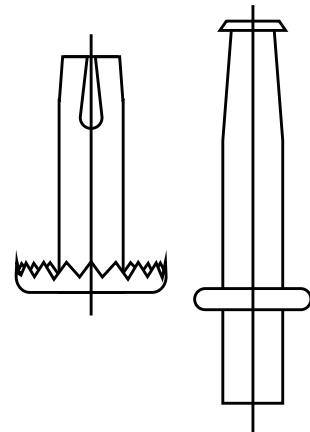

6* = Grip Neck Stem
(furniture casters)

CONTENTS

	SERIES	DESCRIPTION	LOAD CAPACITY	PAGES
FURNITURE CASTERS	TP1300 Series	Twin Wheel Furniture Casters	90 lbs	8
	TP1600 Series	Hooded Ball Furniture Casters	90 lbs	9
LIGHT DUTY CASTERS	TP3000 Series	Light Duty Institutional Casters	130 lbs	10
	TP3200 Series	Light Duty Institutional Casters	150 lbs	11
	TP3600 Series	Light Duty Industrial Casters	220 lbs	12~13
GENERAL DUTY CASTERS	TP4000 Series	General Duty Casters	300 lbs	14~15
LIGHT-MEDIUM DUTY CASTERS	TP5000 Series	Light-Med Duty Industrial Casters	350 lbs	16~19
	TP5100 Series	Light-Med Duty Stainless Steel Casters	350 lbs	20~21
	TP5200 Series	Light-Med Duty Food Service Casters	360 lbs	22~24
	TP5300 Series	Light-Med Duty Food Service Casters	360 lbs	26~27
	TP5400 Series	Light-Med Duty Industrial Casters	300 lbs	25
MEDIUM-HEAVY DUTY CASTERS	TP6200 Series	Medium Heavy Duty Casters	550 lbs	28
	TP6400 Series	Medium Heavy Duty Casters	800 lbs	29
	TP6600 Series	Medium Heavy Duty Casters	1250 lbs	30~33
	TP6600W	Pneumatic & Flat Free Casters	500 lbs	34
	TP6600 KPL	Medium Heavy Duty Kingpinless	1250 lbs	35~37
	TP6700 Series	Medium Duty Stainless Steel	1250 lbs	38~39
	TP6800 Series	Medium Heavy Duty Casters	1400 lbs	40~41
HEAVY DUTY CASTERS	TP6900 Series	Heavy Duty Drop Forged Casters	2000 lbs	42
	TP7000 Series	Heavy Duty Drop Forged Casters	1500 lbs	43
	TP7100 Series	Heavy Duty Drop Forged Casters	4000 lbs	44
	TP7200 Series	Heavy Duty Drop Forged Casters	4000 lbs	45
	TP7200 KPL	Heavy Duty Kingpinless Casters	5400 lbs	46
	TP7500 KPL	Heavy Duty Kingpinless Casters	5400 lbs	47
	TP7500 Series	Heavy Duty Drop Forged Casters	5400 lbs	48
	TP7600 Series	Super Heavy Duty Casters	4400 lbs	49
SPECIAL CASTERS	TP8000 Series	Low-Profile Machine Casters	300 lbs	50
	TP8000 Series	Business Machine Casters	1000 lbs	51
	TP8100 Series	Shopping Cart Casters	250 lbs	52
	TP8200 Series	Stackable Dolly Casters	300 lbs	53
	TP8300 Series	Ladder Casters	125 lbs	54
	TP8900 Series	Scaffold Casters	800 lbs	55
	TP9300 Series	Workstation Casters	1000 lbs	56
	TP9300 Series	New Workstation Casters	3300 lbs	57
	TP9500 Series	Leveling Casters	700 lbs	58
	AUTO INDUSTRIES CASTERS	TP6600MF~TP6601MF	Maintenance Free Casters	1300 lbs
TP7002MF		Maintenance Free Casters	1500 lbs	60
TP9600SA & TP9601SA		Shock Absorbing Casters	1200 lbs	61
MEDICAL CASTERS	TP5501 Series	Medium Duty Nylon Casters	200 lbs	62
	TP8400 Series	Medium Duty Medical Casters	280 lbs	63
	TP8454 Series	Nylon covered Medical Casters	200 lbs	64
	TP8700 Series	Deluxe Total Lock Casters	240 lbs	65
	TP8850 Series	Twin Wheel Medical Casters	230 lbs	66

	SERIES	DESCRIPTION	LOAD CAPACITY	PAGES
	TP9400 Series	Central Locking Casters	300 lbs	67
	TPMC1 Series	Nylon Maintenance Free Medical Casters	300 lbs	68
Polyolefin & Nylon Tread Wheels	LDP	Light Duty Plastic Wheels	250 lbs	69
	NYL	Nylon Wheels	800 lbs	69
	HDP	Heavy Duty Plastic Wheels	800 lbs	70
	NGF	Nylon Glass-Filled Wheels	1400 lbs	71
	RTR	Retort Wheels	950 lbs	71
Thermoplastic Tread Wheels	MIR	Mirage Rubber Wheels (TPR)	600 lbs	72
	MRC	Crowned Mirage Rubber Wheels (TPR)	600 lbs	73
Polyurethane Tread Wheels	PAL	Polyurethane Tread Aluminum Wheels	1500 lbs	74
	PALC	Crowned Polyurethane Tread Aluminum Wheels	1800 lbs	75
	PCI	Polyurethane Tread Cast Iron Wheels	3200 lbs	76
	PCC	Crowned Polyurethane Tread Cast Iron Wheels	1400 lbs	77
	PNY	Polyurethane / Nylon Wheels	1400 lbs	79
	PLX	Solid Polyurethane Wheels	1000 lbs	79
	PLY	Polyurethane Wheels	300 lbs	80
	PRO	Pro-Tech Polyurethane Wheels	1000 lbs	81
	PLE	Hi-Elastic Polyurethane Wheels	175 lbs	82
	PRX	Pro-Tech Extra Polyurethane Wheels	1200 lbs	82
Phenolic & Hi-Temperature Wheels	PHN	Phenolic Wheels	3500 lbs	83
	PHN-HT	Phenolic Hi-Temperature Wheels	2500 lbs	84
	FVR	Fever Hi-Temperature Wheels	1400 lbs	85
	FVT	Fever-Tech Hi-Temperature Wheels	700 lbs	85
Pneumatic & Air Free wheels	PNU	Pneumatic Wheels	500 lbs	86
	AFR	Air / Flat Free Wheels	300 lbs	87
	ZRB / ZRR	Semi-Pneumatic Wheels (Zero)	850 lbs	88
Rubber Tread Wheels	RAL	Rubber / Aluminum Wheels	800 lbs	89
	RND	Rubber Balloon Cushion Wheels	500 lbs	89
	RCI	Rubber Tread Cast Iron Center Wheels	1500 lbs	90
	RNY	Rubber / Nylon Wheels	600 lbs	91
	SR/ HR	Rubber Wheels	280 lbs	92
Steel & Ductiles Wheels	STL	Steel Wheels	2500 lbs	93
	SDI	Ductile Iron Wheels	6500 lbs	94
	VGR	V-Groove Steel Wheels	1000 lbs	95
Parts and Others	AXLE & NUT			96
	BRAKE KITS			97
	BEARING			99
	SPANNER BUSHING			99
	FLOOR TRUCK LOCKS			99
	CONER BUMPER			100
	CASTER DOCK			100

Twin Wheel Furniture Casters

TP1300 Series / Capacity up to 90 Lbs.



Features

- Nylon twin wheels are easy-rolling and non-marking
- Hard and Soft wheels are available

Applications

- Home and office Equipment
- Furniture
- Store Display Stand Fixtures
- Optional brake available

Caster Options

- Brake

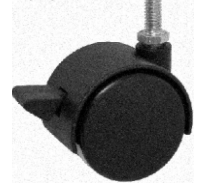

Wheel Diameter	Wheel Type	Swivel Number	Load Capacity	Overall Height
2	Nylon	TP1350-**-*	90	2-3/8
2-3/8	Nylon	TP1360-**-*	120	2-3/4
3	Nylon	TP1375-**-*	150	3-1/8

Replace -**-* in part number with appropriate fastening code.

Fastenings		
TYPE	CODE	SIZE(Inch)
Top Plate	01	Overall Size 1-1/2 x 1-1/2
		Bolt Hole Spacing 1 x 1
		Attaching Bolt Size 5/16
Grip Ring Stem	11	7/16 x 7/8
	12	7/16 x 1
	13	7/16 x 1-3/8
Threaded Stem	21	5/16 - 18 x 1
	22	5/16-18 x 3/4
	23	3/8-16 x 1
	24	3/8-16 x 1-1/2
	25	3/8-16 x 1
	27	5/16-18 1-1/2

Replace -**-* in part number with appropriate fastening code.

Options	
CODE	DESCRIPTION
BRK	Brake

Add Option Code to end of part number.

Hooded Ball Furniture Casters

TP1600 Series / Capacity up to 90 Lbs.

TP1600 Series



Features

- **Swivel:** Double ball bearing raceways
- **Construction:** Styled for home or office use
- **Colors:** Four popular colors
- **Wheel:** Neoprene rubber wheels provide long life and durability

Applications

- Home and office Equipment
- Furniture
- Store Display Stand Fixtures

Caster Options

Wheel Diameter	Wheel Type	Swivel Number	Load Capacity	Overall Height
1-5/8	Neoprene Rubber	TP1640-*-*-##	90	2-1/4
2	Neoprene Rubber	TP1650-*-*-##	90	2-5/8

Replace *-*- in part number with appropriate fastening code.

Replace -##- in part number with appropriate color code.

Fastenings		
TYPE	CODE	SIZE(Inch)
Top Plate	02	Overall Size 1-1/4 x 2
		Bolt Hole Spacing 25/32 x 1-9/16
		Attaching Bolt Size 7/32
Grip Ring Stem	12	7/16 x 1
	13	7/16 x 1-7/16
	14	7/16 x 1-3/16
Threaded Stem	21	5/16 - 18 x 1
	22	5/16-18 x 3/4
	23	5/16-18 x 1-3/8
	24	3/18-16 x 1

Replace *-*- in part number with appropriate fastening code.

Color Options	
CODE	DESCRIPTION
AB	Antique Brass
AC	Antique Copper
BR	Bright Brass
CR	Chrome

Add Option Code to end of part number.

Light Duty Institutional Casters

TP3000 Series / Capacity up to 130 Lbs.



Features

- **Finish:** Bright zinc plating
- **Swivel:** Double ball bearing raceways
- **Construction:** Formed steel for extra strength
- **Axle:** 15/64" diameter axle with lock nut

Applications

- Office Equipment
- Store Display Stand Fixtures
- Utility Carts
- Institutional Equipment
- Furniture & Medical Equipment

Caster Options

- TLB: Top Lock Brake



- SLB: Side Lock Brake



- FLB: Front Lock Brake (2" Only)



Wheel Diameter	Tread Width	Wheel Type	Swivel Number	Wheel Bearing	Load Capacity	Swivel Radius
2	13/16	Soft Rubber	TP3020-**-SR	Nylon	80	1-13/16
		Hard Rubber	TP3020-**-HR	Nylon	90	
		Mirage (TPR)	TP3020-**-MIR	Plain	80	
		Polyurethane	TP3020-**-PLY	Plain	80	
2-1/2	13/16	Soft Rubber	TP3025-**-SR	Nylon	90	2-1/16
		Hard Rubber	TP3025-**-HR	Nylon	100	
3	13/16	Soft Rubber	TP3030-**-SR	Nylon	100	2-3/8
		Hard Rubber	TP3030-**-HR	Nylon	130	
		Mirage (TPR)	TP3030-**-MIR	Plain	100	
		Polyurethane	TP3030-**-PLY	Plain	100	

Fastenings						
TYPE	CODE	SIZE (Inch)		OVERALL HEIGHT		
				TP3020	TP3025	TP3030
Top Plate	01	Overall Size	1-1/4 x 2-1/16	2-5/8	3-1/8	3-5/8
		Bolt Hole Spacing	13/16 x 1-9/16			
		Attaching Bolt Size	3/16			
Grip Ring Stem	10	7/16 x 7/8		2-5/8	3-1/8	3-5/8
	12	7/16 x 1-7/16				
Threaded Stem	21	5/16-18 x 1		2-17/32	3-1/16	3-17/32
	22	5/16-18 x 3/4				
	23	3/8-16 x 1				
	24	3/8-16 x 1-1/4				
	25	3/8-16 x 1-1/2				
	26	3/8-16 x 1/2				
	27	5/16-18 x 3/8				
	28	5/16-18 x 1/2				

Options	
CODE	DESCRIPTION
BX	Black Oxide Plating
CR	Chrome Plating
NK	Nickel Plating
RoHS	RoHS compliant
FLB	Front Lock Brake (TP3020 Only)
SLB	Side Lock Brake
TLB	Top Lock Brake

Add Option Code to end of part number.

Replace -**- in part number with appropriate fastening code.

Wheel Options

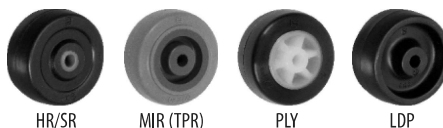

HR/SR

MIR (TPR)

PLY

LDP

Light Duty Institutional Casters

TP3200 Series / Capacity up to 150 Lbs.

TP3200 Series



Features

- **Finish:** Bright zinc plating
- **Swivel:** Double ball bearing raceways
- **Construction:** Formed steel for extra strength
- **Axle:** 1/4" diameter axle with lock nut

Applications

- Office Equipment
- Store Display Stand Fixtures
- Utility Carts
- Institutional Equipment
- Furniture & Medical Equipment

Caster Options

- TLB: Top Lock Brake



- -01-Top Plate



Wheel Diameter	Tread Width	Wheel Type	Swivel Number	Wheel Bearing	Load Capacity	Swivel Radius
2	15/16	Soft Rubber	TP3220-**-SR	Nylon	90	2
		Hard Rubber	TP3220-**-HR	Nylon	125	
		Mirage Rubber (TPR)	TP3220-**-MIR	Plain	90	
		Polyurethane	TP3220-**-PLY	Plain	90	
		Steel	TP3220-**-STL	Plain	125	
Light Duty Plastic	TP3220-**-LDP	Plain	125			
3	15/16	Soft Rubber	TP3230-**-SR	Nylon	110	2-1/2
		Hard Rubber	TP3230-**-HR	Nylon	150	
		Light Duty Plastic	TP3230-**-LDP	Plain	150	

Fastenings					
TYPE	CODE	SIZE (Inch)		OVERALL HEIGHT	
				TP3220	TP3230
Top Plate	01	Overall Size	2-3/4 x 3-3/4	2-13/16	3-7/8
		Bolt Hole Spacing	1-3/4 x 2-15/16		
		Attaching Bolt Size	5/16		
Grip Ring Stem	11	7/16 x 1-7/16		2-13/16	3-7/8
Threaded Stem	21	5/16-18 x 1		2-11/16	3-23/32
	22	5/16-18 x 3/4			
	23	3/8-16 x 1			
	24	3/8-16 x 1-1/4			
	27	1/2-13 x 5/8			

Options	
CODE	DESCRIPTION
BX	Black Oxide Plating
CR	Chrome Plating
NK	Nickel Plating
RoHS	RoHS compliant
TLB	Top Lock Brake

Add Option Code to end of part number

Replace**-**in part number with appropriate fastening code.

Wheel Options

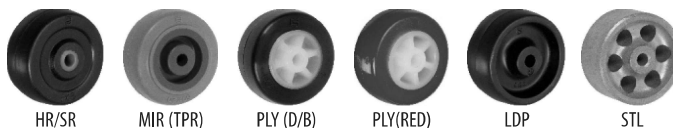

HR/SR

MIR (TPR)

PLY (D/B)

PLY (RED)

LDP

STL

Light Duty Industrial Casters

TP3600 Series / Capacity up to 200 Lbs.



Features

- **Finish:** Bright zinc plating
- **Swivel:** Double ball bearing raceways
- **Rigid:** Single piece pressed to form for extra strength
- **Construction:** Heavy duty gauge steel formed for extra strength
- **Axle:** 5/16" diameter axle with lock nut
- **Applicators:** Rubber Expanding Adapters & Pipe Threaded Stems available
- Octagonal upper cup standard on threaded stem casters

Applications

- Utility Stock Carts
- Institutional equipment
- Food service equipment
- Display Racks

Caster Options

- TLB: Top Lock Brake

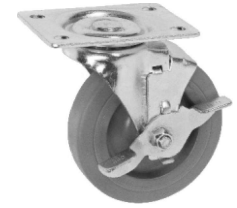

- REA: Rubber Expanding Adapter



- Rigid



- PS: Pipe Stem



Wheel Diameter	Tread Width	Wheel Type	Swivel Number	Rigid Number	Wheel Bearing	Load Capacity	Overall Height	Swivel Radius
3	1	Mirage (TPR)	TP3630-**-MIR	TP3630R-01-MIR	Plain	120	3-3/4	2-5/8
		Soft Rubber	TP3630-**-SR	TP3630R-01-SR	Nylon	130		
		Hard Rubber	TP3630-**-HR	TP3630R-01-HR	Nylon	150		
		Light Duty Plastic	TP3630-**-LDP	TP3630R-01-LDP	Plain	150		
4	1	Mirage (TPR)	TP3640-**-MIR	TP3640R-01-MIR	Plain	130	4-3/4	3-1/8
		Soft Rubber	TP3640-**-SR	TP3640R-01-SR	Nylon	145		
		Hard Rubber	TP3640-**-HR	TP3640R-01-HR	Nylon	160		
		Light Duty Plastic	TP3640-**-LDP	TP3640R-01-LDP	Plain	175		
5	1	Mirage (TPR)	TP3650-**-MIR	TP3650R-01-MIR	Plain	140	5-3/4	3-3/4
		Soft Rubber	TP3650-**-SR	TP3650R-01-SR	Nylon	150		
		Hard Rubber	TP3650-**-HR	TP3650R-01-HR	Nylon	170		
		Light Duty Plastic	TP3650-**-LDP	TP3650R-01-LDP	Plain	200		

Light Duty Industrial Casters

TP3600 Series

Fastenings			
Type	CODE	SIZE (Inch)	
Top Plate	01	Overall Size	2-3/4 x 3-3/4
		Bolt Hole Spacing	1-3/4 x 2-7/8 slotted to 3"
		Attaching Bolt Size	5/16
Grip Ring Stem	11	7/16 x 1-1/2	
Threaded Stem	20	1/2 - 13 x 1"	
	21	1/2 - 13 x 1-1/2"	
	22	7/16 - 14 x 2-1/4"	
	26	1/2 - 13 x 2-3/4" half threaded for REA-Stem kits	
Rubber Expanding Adapter	CODE	ID of Tube	Size Range
	71	3/4"	0.720" ~ 0.851"
	72	7/8"	0.852" ~ 0.927"
	72A	1"	0.928" ~ 1.029"
	73	1-1/8"	1.030" ~ 1.140"
	74	1-3/16"	1.178" ~ 1.303"
	75	1-3/8"	1.360" ~ 1.425"
76	1-1/2"	1.426" ~ 1.589"	
77	1-3/4"	1.685" ~ 1.80"	
Pipe Stem	CODE	Threaded Size (NPT)	Pipe Socket # Only
	81	3/4"	PS-81
	82	1"	PS-82
	83	1-1/4"	PS-83

Options	
CODE	DESCRIPTION
CR	Chrome Plating
TLB	Top Lock Brake

Add Option Code to end of part number.

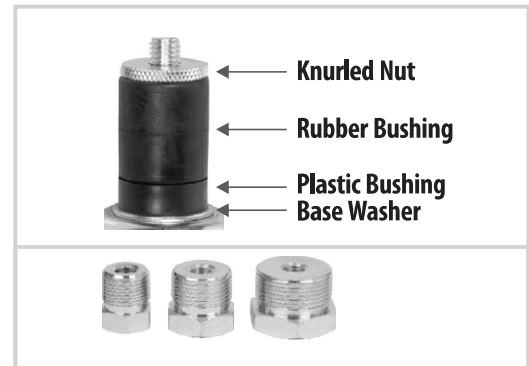

Replace -** - in part number with appropriate fastening code.

Wheel Options

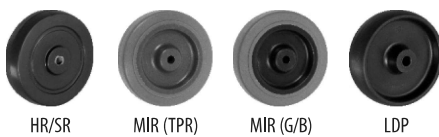

Caster Selection Guide



General Duty Casters

TP4000 Series / Capacity up to 300 Lbs.



Features

- **Finish:** Bright zinc plating
- **Swivel:** Single ball bearing raceway
- **Rigid:** Pressed with heavy duty gauge steel for extra strength
- **Construction:** Heavy duty gauge steel formed for extra strength
- **Axle:**
 - 1-1/2" wheels use 15/64" diameter axle with lock nut
 - 2" wheels use 1/4" diameter axle with lock nut
 - 2-1/2" wheels use 5/16" diameter axle with lock nut
 - 3" wheels use 3/8" diameter axle with lock nut
 - 4" wheels use 3/8 or 7/16" diameter axle with lock nut

Applications

- Dollies
- Institutional equipment
- Furnitures
- Display & Merchandiser Racks

Caster Options

- SLB: Side Lock Brake

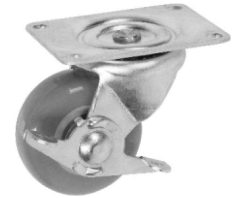

- FLB: Front Lock Brake (TP4020 Only)

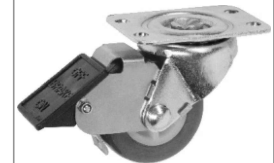

- RIGID



- SO: Short Offset



Wheel Diameter	Tread Width	Wheel Type	Swivel Number	Rigid Number	Wheel Bearing	Load Capacity	Overall Height	Swivel Radius
1-1/8	9/16	Light Duty Plastic	TP4011-01-LDP	--	Plain	30	1-9/16	7/8
1-1/4	9/16	Polyurethane	TP4012-01-PLY	TP4012R-01-PLY	Plain	30	1-3/4	1
1-1/2	3/4	Light Duty Plastic	TP4015-01-LDP	TP4015R-01-LDP	Plain	60	2-3/16	1-9/16
2	1	Mirage (TPR)	TP4020-01-MIR	TP4020R-01-MIR	Plain	90	2-7/16	1-3/4
		Soft Rubber	TP4020-01-SR	TP4020R-01-SR	Nylon	90		
		Hard Rubber	TP4020-01-HR	TP4020R-01-HR	Nylon	125		
		Light Duty Plastic	TP4020-01-LDP	TP4020R-01-LDP	Plain	125		
		Steel	TP4020-01-STL	TP4020R-01-STL	Plain	125		
TP4020-01-PLY	TP4020R-01-PLY	Plain	90					
2-1/2	1-1/8	Soft Rubber	TP4025-01-SR	TP4025R-01-SR	Nylon	100	3-1/4	2-3/8
		Hard Rubber	TP4025-01-HR	TP4025R-01-HR	Nylon	175		
		Light Duty Plastic	TP4025-01-LDP	TP4025R-01-LDP	Plain	175		
		Steel	TP4025-01-STL	TP4025R-01-STL	Plain	200		
TP4025-01-PLY-PB	TP4025R-01-PLY-PB	Plain	100					
3	1-1/4	Mirage (TPR)	TP4030-01-MIR-PB	TP4030R-01-MIR-PB	Plain	200	3-3/4	2-3/4
		Soft Rubber	TP4030-01-SR	TP4030R-01-SR	Nylon	125		
		Hard Rubber	TP4030-01-HR	TP4030R-01-HR	Nylon	250		
		Light Duty Plastic	TP4030-01-LDP	TP4030R-01-LDP	Plain	210		
		Heavy Duty Plastic	TP4030-01-HDP	TP4030R-01-HDP	Plain	250		
		Steel	TP4030-01-STL	TP4030R-01-STL	Plain	250		
		Polyurethane	TP4030-01-PLY	TP4030R-01-PLY	Ball	250		
TP4030-01-PLY-PB	TP4030R-01-PLY-PB	Plain	250					
4	1-1/4	Soft Rubber	TP4040-01-SR	TP4040R-01-SR	Nylon	200	5	2-1/4
		Hard Rubber	TP4040-01-HR	TP4040R-01-HR	Nylon	300		
		Heavy Duty Plastic	TP4040-01-HDP	TP4040R-01-HDP	Plain	300		
		Steel	TP4040-01-STL	TP4040R-01-STL	Plain	300		

General Duty Casters

TP4000 Series

Top Plate Specifications				
WHEEL DIAMETER (inch)	OVERALL SIZE (inch)	BOLT HOLE SPACING (inch)	ATTACHING BOLT SIZE (inch)	
SWIVEL				
1-1/8	(TP4011-01)	1-3/16 x 1-25/32	25/32 x 1-3/8	
1-1/4	(TP4012-01)	1-3/16 x 2-3/8	1-3/4	
1-1/2	(TP4015-01)	1-1/2 x 2-5/32	1-1/16 x 1-47/64	
2	(TP4020-01)	1-7/8 x 2-9/16	15/16 x 2-1/8	
2-1/2	(TP4025-01)	2-3/4 x 3-7/8	1-3/4 x 3	
3	(TP4030-01)	3-1/8 x 4-1/8	2-3/8 x 3-3/8 to 3-7/16	
	(TP4030-03)	3-1/8 x 4-1/8	1-3/4 x 3 to 2-3/8 x 3-3/8	
4	(TP4040-01)	4 x 5-1/8	3 x 4	
RIGID				
1-1/4	(TP4012R-01)	1 x 2-3/8	1-23/32	
1-1/2	(TP4015R-01)	1-1/2 x 2-5/32	1-1/16 x 1-47/64	
2	(TP4020R-01)	1-1/2 x 2-21/32	15/16 x 2-1/8	
2-1/2	(TP4025R-01)	2-1/4 x 4-7/16	1-1/16 x 3-1/2	
3	(TP4030R-01)	2-1/2 x 4-15/16	1-3/16 x 4	
4	(TP4040R-01)	3-1/8 x 6-1/4	1-3/4 x 5	

Options	
CODE	DESCRIPTION
BX	Black Oxide Plating
SLB	Side Lock Brake (PB Type Wheel Only)
FLB	Front Lock Brake (2" Only)
SO	Short Offset

Add Option Code to end of part number.

Caster Selection Guide

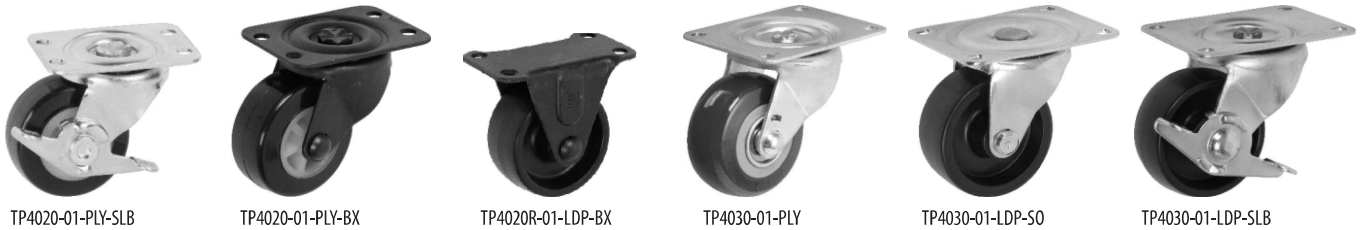

Wheel Options

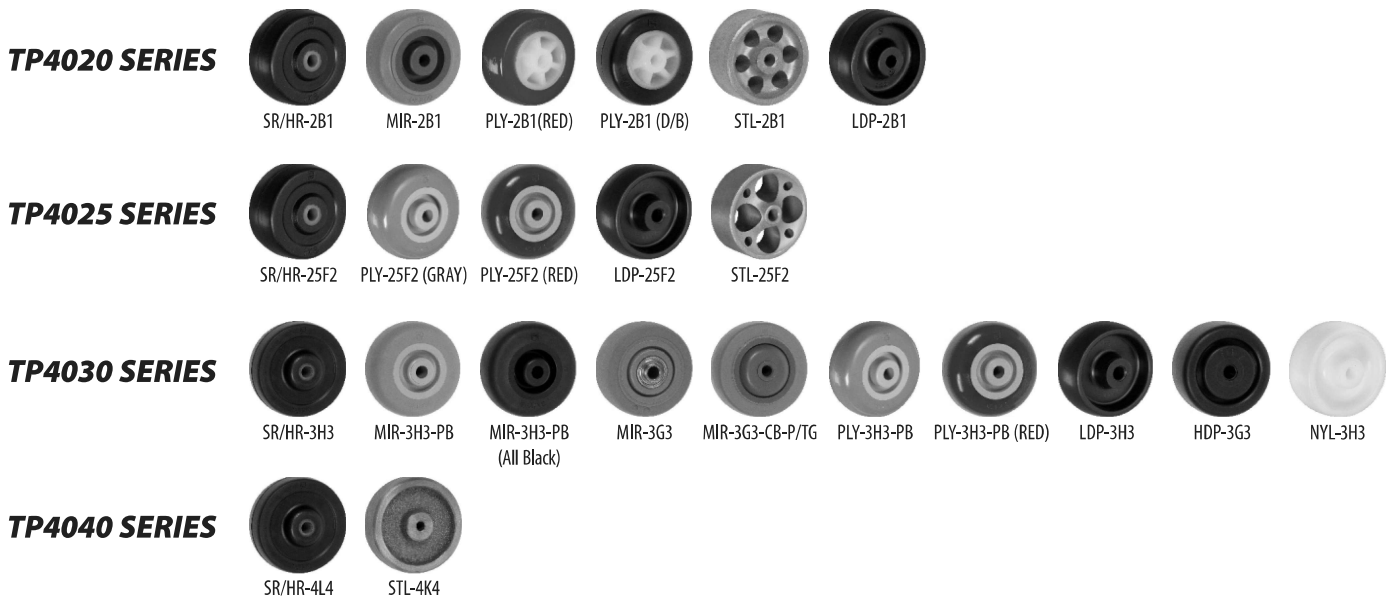

Light-Medium Duty Industrial Casters

TP5000 Series / Capacity up to 350 Lbs.



Features

- **Finish:** Bright zinc plating
- **Swivel:** Double ball bearing raceways
- **Rigid:** Pressed or welded with heavy duty gauge steel for extra strength U-Bracket available (4" & 5" only)
- **Construction:** Heavy duty gauge steel formed for extra strength
- **Axle:** 3/8" diameter axle with lock nut
- **Applicators:** Rubber Expanding Adapters & Pipe Threaded Stems available
- **Lower Nut:** Standard on Threaded Stem Casters

Applications

- Bakery & Food Service Equipment
- Institutional, Hotel & Hospital Equipment
- Laboratory Equipment
- L/M duty Material Handling Equipment
- Moving Dollies
- Office & Store Fixtures
- Utility & Maintenance Carts

Caster Options

- TLB: Top Lock Brake



- SWB: Swivel and Wheel Brake (Total Lock)



- Rigid



- PS: Pipe Stem



- REA: Rubber Expanding Adapter



Fastenings			
TYPE	CODE	SIZE (Inch)	
Top Plate	01	Overall Size	Small 2-1/2 x 3-3/4
		Bolt Hole Spacing	1-3/4 x 2-3/4 slotted to 3
		Attaching Bolt Size	5/16
	02	Overall Size	Large 3-3/4 x 4-1/2
		Bolt Hole Spacing	2-5/8 x 3-5/8 slotted to 3 x 3
		Attaching Bolt Size	3/8
03	Overall Size	Medium 3-1/8 x 4-1/8	
	Bolt Hole Spacing	1-3/4 x 3 slotted to 2-3/8 x 3-3/8	
	Attaching Bolt Size	5/16	
Threaded Stem	21	1/2 - 13 x 1	
	22	1/2 - 13 x 1-1/2	
	23	1/2 - 13 x 2	
	24	1/2 - 13 x 2-1/2	
	25	1/2 - 13 x 2-3/4 (fully threaded)	
	26	1/2 - 13 x 2-3/4 (threaded 1-1/2" from top)	
	29	3/4-10 x 1-1/2	
Round Plain	31	7/8 x 2-3/16 with 5/16 hole cross-drilled	
Octagon Stem	41	3/4 x 2-7/16 with 3 (5/16) holes cross-drilled	
Rubber Expanding Adapter	CODE	ID of Tube	Size Range
	71	3/4"	0.720" ~ 0.851"
	72	7/8"	0.852" ~ 0.927"
	72A	1"	0.928" ~ 1.029"
	73	1-1/8"	1.030" ~ 1.140"
	74	1-3/16"	1.178" ~ 1.303"
	75	1-3/8"	1.360" ~ 1.425"
	76	1-1/2"	1.426" ~ 1.589"
77	1-3/4"	1.685" ~ 1.80"	
Pipe Stem	CODE	Threaded Size (NPT)	Pipe Socket # Only
	81	3/4"	PS-81
	82	1"	PS-82
	83	1-1/4"	PS-83

Replace -**- in part number with appropriate fastening code.

Options	
CODE	DESCRIPTION
CR	Chrome Plating
BR	Bright Brass Plating
TG	Thread Guard (Bearing Type Wheels Only)
SWB	Total Lock Swivel & Wheel Brake
TLB	Top Lock Brake

Add Option Code to end of part number.

Light-Medium Duty Industrial Casters

TP5000 Series

Wheel Diameter	Tread Width	Wheel Type	Swivel Number	Rigid Number	Wheel Bearing	Load Capacity	Overall Height	Swivel Radius	
3	1-1/4	Mirage (TPR)	TP5030-**-MIR	TP5030R-**-MIR	Precision	225	4-1/8	2-7/8	
		Mirage (TPR)	TP5030-**-MIR-CB	TP5030R-**-MIR-CB	Precision	225			
		Mirage (TPR)	TP5030-**-MIR-PB	TP5030R-**-MIR-PB	Plain	225			
		Soft Rubber	TP5030-**-SR	TP5030R-**-SR	Nylon	150			
		Soft Rubber	TP5030-**-SRB	TP5030R-**-SRB	Ball	150			
		Hard Rubber	TP5030-**-HR	TP5030R-**-HR	Nylon	220			
		Hard Rubber	TP5030-**-HRB	TP5030R-**-HRB	Ball	220			
		Light Duty Plastic	TP5030-**-LDP	TP5030R-**-LDP	Plain	250			
	1-3/8	Heavy Duty Plastic	TP5030-**-HDP	TP5030R-**-HDP	Plain	300			
		Heavy Duty Plastic	TP5030-**-HPB	TP5030R-**-HPB	Ball	300			
		Steel	TP5030-**-STL	TP5030R-**-STL	Plain	300			
		Polyurethane	TP5030-**-PLY	TP5030R-**-PLY	Ball	250			
	1-1/4	Polyurethane	TP5030-**-PLY-CB	TP5030R-**-PLY-CB	Precision	250			
		Polyurethane	TP5030-**-PLY-PB	TP5030R-**-PLY-PB	Plain	250			
		Solid Polyurethane	TP5030-**-PLX-PB	TP5030R-**-PLX-PB	Plain	250			
		Phenolic	TP5030-**-PHN-PB	TP5030R-**-PHN-PB	Plain	250			
Fever Nylon Hi-Temp		TP5030-**-FVR-PB	TP5030R-**-FVR-PB	Plain	250				
High Elastic Polyurethane		TP5030-**-PLE	TP5030R-**-PLE	Precision	125				
3-1/2	1-1/4	Mirage (TPR)	TP5035-**-MIR	TP5035R-**-MIR	Precision	250	4-5/8	3-1/4	
		Mirage (TPR)	TP5035-**-MIR-CB	TP5035R-**-MIR-CB	Precision	250			
		Polyurethane	TP5035-**-PLY-CB	TP5035R-**-PLY-CB	Precision	250			
4	1-1/4	Mirage (TPR)	TP5040-**-MIR	TP5040R-**-MIR	Annular	250	5-1/16	3-1/2	
		Mirage (TPR)	TP5040-**-MIR-CB	TP5040R-**-MIR-CB	Precision	250			
		Mirage (TPR)	TP5040-**-MIR-PB	TP5040R-**-MIR-PB	Plain	250			
		Soft Rubber	TP5040-**-SR	TP5040R-**-SR	Nylon	175			
		Soft Rubber	TP5040-**-SRB	TP5040R-**-SRB	Ball	175			
		Hard Rubber	TP5040-**-HR	TP5040R-**-HR	Nylon	255			
		Hard Rubber	TP5040-**-HRB	TP5040R-**-HRB	Ball	255			
		Polyurethane	TP5040-**-PLY	TP5040R-**-PLY	Ball	280			
		Polyurethane	TP5040-**-PLY-CB	TP5040R-**-PLY-CB	Precision	280			
		Polyurethane	TP5040-**-PLY-PB	TP5040R-**-PLY-PB	Plain	280			
		Solid Polyurethane	TP5040-**-PLX-PB	TP5040R-**-PLX-PB	Plain	300			
		High Elastic Polyurethane	TP5040-**-PLE	TP5040R-**-PLE	Precision	165			
	1-15/32	Light Duty Plastic	TP5040-**-LDP	TP5040R-**-LDP	Plain	225			
		Heavy Duty Plastic	TP5040-**-HDP	TP5040R-**-HDP	Plain	300			
		Heavy Duty Plastic	TP5040-**-HPB	TP5040R-**-HPB	Ball	300			
		1-1/4	Steel	TP5040-**-STL	TP5040R-**-STL	Plain			300
	Phenolic		TP5040-**-PHN	TP5040R-**-PHN	Roller	300			
	Phenolic		TP5040-**-PHN-PB	TP5040R-**-PHN-PB	Plain	300			
	Phenolic Hi-Temp		TP5040-**-PHN-HT	TP5040R-**-PHN-HT	Roller	300			
	Phenolic Hi-Temp		TP5040-**-PHN-PB-HT	TP5040R-**-PHN-PB-HT	Plain	300			
Fever Nylon Hi-Temp	TP5040-**-FVR		TP5040R-**-FVR	Roller	300				
1-1/2	Fever Nylon Hi-Temp	TP5040-**-FVR-PB	TP5040R-**-FVR-PB	Plain	300				
	Fever-Tech Epoxy Hi-Temp	TP5040-**-FVT	TP5040R-**-FVT	Precision Ball	300				
	5	1-1/4	Mirage (TPR)	TP5050-**-MIR	TP5050R-**-MIR	Precision	300	6-1/8	4
			Mirage (TPR)	TP5050-**-MIR-CB	TP5050R-**-MIR-CB	Precision	300		
Mirage (TPR)			TP5050-**-MIR-PB	TP5050R-**-MIR-PB	Plain	300			
Mirage (TPR)			TP5050-**-MRC-CB	TP5050R-**-MRC-CB	Plain	300			
Soft Rubber			TP5050-**-SR	TP5050R-**-SR	Nylon	200			
Soft Rubber			TP5050-**-SRB	TP5050R-**-SRB	Ball	200			
Hard Rubber			TP5050-**-HR	TP5050R-**-HR	Nylon	280			
Hard Rubber			TP5050-**-HRB	TP5050R-**-HRB	Ball	280			
Polyurethane			TP5050-**-PLY	TP5050R-**-PLY	Ball	300			
Polyurethane			TP5050-**-PLY-CB	TP5050R-**-PLY-CB	Precision	300			
Polyurethane			TP5050-**-PLY-PB	TP5050R-**-PLY-PB	Plain	300			
Solid Polyurethane			TP5050-**-PLX-PB	TP5050R-**-PLX-PB	Plain	350			
High Elastic Polyurethane		TP5050-**-PLE	TP5050R-**-PLE	Precision	175				
1-15/32		Heavy Duty Plastic	TP5050-**-HDP	TP5050R-**-HDP	Plain	350			
		Heavy Duty Plastic	TP5050-**-HPB	TP5050R-**-HPB	Ball	350			
		1-1/2	Phenolic	TP5050-**-PHN	TP5050R-**-PHN	Roller	350		
	Phenolic		TP5050-**-PHN-PB	TP5050R-**-PHN-PB	Plain	350			
Phenolic Hi-Temp	TP5050-**-PHN-HT		TP5050R-**-PHN-HT	Roller	350				
Phenolic Hi-Temp	TP5050-**-PHN-PB-HT		TP5050R-**-PHN-PB-HT	Plain	350				
Fever Nylon Hi-Temp	TP5050-**-FVR		TP5050R-**-FVR	Roller	350				
Fever Nylon Hi-Temp	TP5050-**-FVR-PB		TP5050R-**-FVR-PB	Plain	350				

Light-Medium Duty Industrial Casters

Caster Selection Guide for TP5000 Series



TP5050-01-PLY-CB (D/B)
(2-1/2x 3-3/4)



TP5050-02-PLY-CB-F/TG-TLB (MAROON)
(3-3/4 x 4-1/2)



TP5040-03-PLY-CB (RED)
(3-1/8 x 4-1/8)



TP5050-21-LN-MIR-CB-F/TG
(1/2-13x1)



TP5040-22-LN-MIR-SWB
(1/2-13x 1-1/2")



TP5050-81-LN-PLY-CB-P/TG
(Pipe Stem)



TP5050-76-LN-HDP-F
(Rubber Expanding Adapter)



TP5050-31-HDP
(7/8x 2-3/16)



TP5050-41-PRO-ZA
(3/4x2-7/16)



TP5040-01-PHN
T.R.: -45°F~+250°F



TP5040-03-PHN-PB-HT
Temp. Range : 475°F



TP5040-01-FVT-BB (HT)
Temp. Range : 475°F



TP5040-02-FVR-PB-HT-ZA
Temp. Range : -45°F~+475°F



TP5050R-01-PLY (RED)
(2-1/2 x 3-3/4)



TP5050R-02-NYL
(3-3/4 x 4-1/2)

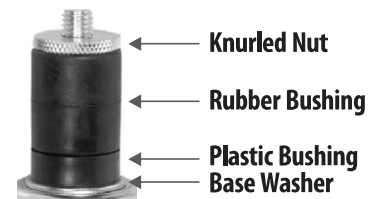

Rubber Expanding Adapter

Light-Medium Duty Industrial Casters

Wheel Selection Guide for TP5000, TP5100, TP5200, TP5300 & TP5400 Series

TP5000 Series



HR/SR-5H3



HRB/SRB-4H3



LDP-4H3, 5H3



HDP-3G3



HDP-4K3, 5K3
(Spoke Type)



HDP-5K3-F
(Flat Type)



NYL-4H3, 5H3

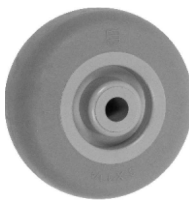

MIR-3H3-PB

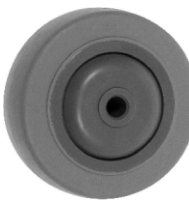

MIR-3G3-CB-P/TG
35G3-CB-P/TG
(Precision Bearing)



MIR-4G3-CB
5G3-CB
(Precision Bearing)



MIR-5G3



MIR-5H3-PB



MIR-5G3-CB-F/TG



PLY-35G3-CB-P/TG



PLY-3H3-PB



PLY-5J3-CB-F/TG (MAROON)



PLY-5J3



PLY-5J3-CB (RED)



PLY-5J3-CB (GRAY)
(Precision Bearing)



PLY-5J2-TG(S)
(Shopping Cart Wheel)



PLX-5H5-PB



PRO-5K0



PLE-5H3



PHN-5H5-PB
T.R.: -45°F~+250°F



PHN-5K0
T.R.: -45°F~+250°F



PHN-4H5-PB-HT
T.R.: 475°F/550°F



PHN-4K0-HT
T.R.: 475°F/550°F



FVR-4H5-PB-HT
T.R.: 475°F/525°F



FVR-4K5-PB-HT (BLACK)
T.R.: 475°F/525°F



FVT-4K3-PB-HT
T.R.: 475°F/525°F

Light-Medium Stainless Steel Casters

TP5100 Series / Capacity up to 350 Lbs.



Features

- **Top Plate:** 5/32" 304 Stainless steel plate
- **Swivel:** Stainless steel double ball bearing raceways. Zerk in swivel section
- **Kingpin:** 1/2" Stainless steel
- **Legs:** 304 Stainless steel plate
- **Axle:** 3/8" diameter stainless steel axle with lock nut

Applications

- Food Service & Restaurants Carts
- Washdown Applications
- Hospitals & Institutions

Caster Options

- TLB: Top Lock Brake



- SWB: Metal Pedal Total Lock



- Rigid



Fastenings		
TYPE	CODE	SIZE (Inch)
Top Plate	01	Overall Size Small 2-3/8 x 3-5/8
		Bolt Hole Spacing 1-3/4 x 2-3/4 slotted to 3
		Attaching Bolt Size 5/16
	02	Overall Size Medium 3-1/8 x 4-1/8
		Bolt Hole Spacing 1-3/4 x 3 slotted to 2-3/8 x 3-3/8
		Attaching Bolt Size 5/16
03	Overall Size Large 3-3/4 x 4-1/2	
	Bolt Hole Spacing 2-5/8 x 3-5/8 slotted to 3 x 3	
	Attaching Bolt Size 3/8	
Grip Ring Stem	11	7/16 x 1-1/2
	12	0.845 x 2-3/16
Threaded Stem	21	1/2 - 13 x 1
	22	1/2 - 13 x 1-1/2
	23	1/2 - 13 x 2
	24	1/2 - 13 x 2-1/2
	26	1/2 - 13 x 2-3/4 (fully threaded)

Options	
CODE	DESCRIPTION
TLB	Top Lock Brake
SWB	Metal Pedal Total Lock Brake
ZA	Zerk Axle & Nut

Add Option Code to end of part number.

Replace -*- in part number with appropriate fastening code.

Light-Medium Stainless Steel Casters

TP5100 Series

Wheel Diameter	Tread Width	Wheel Type	Swivel Number	Rigid Number	Wheel Bearing	Load Capacity	Overall Height	Swivel Radius			
3	1-1/4	Mirage (TPR)	TP5130D-**-MIR-PB	TP5130R-**-MIR-PB	Plain	250	4-1/8	2-7/8			
		Light Duty Plastic	TP5130D-**-LDP	TP5130R-**-LDP	Plain	210					
	1-3/8	Heavy Duty Plastic	TP5130D-**-HDP	TP5130R-**-HDP	Plain	300					
		Nylon	TP5130D-**-NYL	TP5130R-**-NYL	Plain	250					
	1-1/4	Polyurethane	TP5130D-**-PLY-PB	TP5130R-**-PLY-PB	Plain	250					
		Solid Polyurethane	TP5130D-**-PLX-PB	TP5130R-**-PLX-PB	Plain	300					
4	1-1/4	Mirage (TPR)	TP5140D-**-MIR-PB	TP5140R-**-MIR-PB	Plain	250	5-1/4	3-1/4			
		Polyurethane	TP5140D-**-PLY-PB	TP5140R-**-PLY-PB	Plain	280					
		Solid Polyurethane	TP5140D-**-PLX-PB	TP5140R-**-PLX-PB	Plain	300					
		Light Duty Plastic	TP5140D-**-LDP	TP5140R-**-LDP	Plain	225					
	1-15/32	Heavy Duty Plastic	TP5140D-**-HDP	TP5140R-**-HDP	Plain	300					
		Nylon	TP5140D-**-NYL	TP5140R-**-NYL	Plain	280					
	1-1/2	Phenolic	TP5140D-**-PHN	TP5140R-**-PHN	Roller	300					
		Phenolic	TP5140D-**-PHN-PB	TP5140R-**-PHN-PB	Plain	300					
		Phenolic Hi-Temp	TP5140D-**-PHN-HT	TP5140R-**-PHN-HT	Roller	300					
		Phenolic Hi-Temp	TP5140D-**-PHN-PB-HT	TP5140R-**-PHN-PB-HT	Plain	300					
		Fever Nylon Hi-Temp	TP5140D-**-FVR	TP5140R-**-FVR	Roller	300					
		Fever Nylon Hi-Temp	TP5140D-**-FVR-PB	TP5140R-**-FVR-PB	Plain	300					
	5	1-1/4	Mirage (TPR)	TP5150D-**-MIR-PB	TP5150R-**-MIR-PB	Plain			300	6-1/4	4
			Polyurethane	TP5150D-**-PLY-PB	TP5150R-**-PLY-PB	Plain			300		
Solid Polyurethane			TP5150D-**-PLX-PB	TP5150R-**-PLX-PB	Plain	350					
1-15/32		Heavy Duty Plastic	TP5150D-**-HDP	TP5150R-**-HDP	Plain	350					
		Nylon	TP5150D-**-NYL	TP5150R-**-NYL	Plain	350					
1-1/2		Phenolic	TP5150D-**-PHN	TP5150R-**-PHN	Roller	350					
		Phenolic	TP5150D-**-PHN-PB	TP5150R-**-PHN-PB	Plain	350					
		Phenolic Hi-Temp	TP5150D-**-PHN-HT	TP5150R-**-PHN-HT	Roller	350					
		Phenolic Hi-Temp	TP5150D-**-PHN-PB-HT	TP5150R-**-PHN-PB-HT	Plain	350					
		Fever Nylon Hi-Temp	TP5150D-**-FVR	TP5150R-**-FVR	Roller	350					
		Fever Nylon Hi-Temp	TP5150D-**-FVR-PB	TP5150R-**-FVR-PB	Plain	350					

Wheel Options

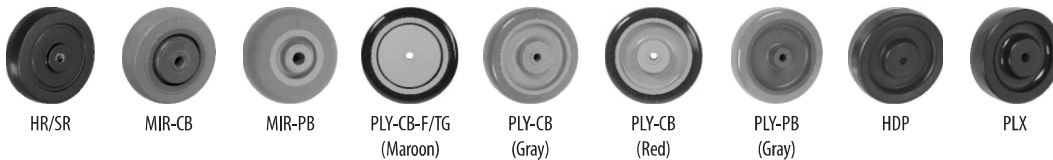

Caster Selection Guide



Light-Medium Duty Food Service Casters

TP5200 Series / Capacity up to 360 Lbs.



Features

- **Finish:** Bright zinc plating or Bright nickel plating
- **Swivel:** Double ball bearing with hardened raceways for extra strength
- **Rigid:** Pressed or welded with heavy duty gauge steel for extra strength
- **Axle:** 3/8" diameter axle with lock nut
- **Dust Cover:** Helps protect swivel bearings
- **Applicators:** Rubber Expanding Adapters & Pipe Threaded Stems available
- **Lower Nut:** Standard on Threaded Stem Casters

Applications

- Bakery & Food Service Equipment
- Institutional, Hotel & Hospital Equipment
- Laboratory Equipment
- Material Handling Equipment
- Moving Dollies
- Office & Store Fixtures
- Utility & Maintenance Carts

Caster Options

- TLB: Top Lock Brake



- FLB: Front Lock Brake



- U - Bracket with Stem



- Rigid



- Expanding Adapter Stem



- ZS: Zerk fitting on Swivel Raceway



Fastenings			
TYPE	CODE	SIZE (Inch)	
Top Plate	01	Overall Size	Small 2-3/8 x 3-5/8
		Bolt Hole Spacing	1-3/4 x 2-3/4 slotted to 3
		Attaching Bolt Size	5/16
	02	Overall Size	Medium 3-1/8 x 4-1/8
		Bolt Hole Spacing	1-3/4 x 3 slotted to 2-3/8 x 3-3/8
		Attaching Bolt Size	5/16
03	Overall Size	Large 3-3/4 x 4-1/2	
	Bolt Hole Spacing	2-5/8 x 3-5/8 slotted to 3 x 3	
	Attaching Bolt Size	3/8	
Grip Ring Stem	11	7/16 x 1-3/8	
	12	0.845 x 2-3/16	
Threaded Stem	21	1/2 - 13 x 1	
	22	1/2 - 13 x 1-1/2	
	26	1/2 - 13 x 2-3/4 (threaded 1-1/2" from top)	
	27	5/8 - 11 x 1-1/2	
	28	5/8 - 11 x 1	
Hand Truck Stem	33	1 x 2-1/2 with one 5/16 hole drilled 9/16" up from base one 3/8 hole drilled 1-3/16 up from base	
Square Stem	51	0.845 x 2-1/2. 1" & 2" up from base (1/4" cross-drilled hole)	
	52	7/8 x 2-1/2. 1" & 2-1/8 up from base (1/4" cross-drilled hole)	
Rubber Expanding Adapter	CODE	ID of TUBE	SIZE RANGE
	71	3/4"	0.720" ~ 0.851"
	72	7/8"	0.852" ~ 0.927"
	72A	1"	0.928" ~ 1.029"
	73	1-1/8"	1.030" ~ 1.140"
	74	1-3/16"	1.178" ~ 1.303"
	75	1-3/8"	1.360" ~ 1.425"
	76	1-1/2"	1.426" ~ 1.589"
77	1-3/4"	1.685" ~ 1.80"	
Pipe Stem	CODE	Threaded Size (NPT)	Pipe Socket # Only
	81	3/4"	PS-81
	82	1"	PS-82
	83	1-1/4"	PS-83

Replace *- *- in part number with appropriate fastening code.

Options	
CODE	DESCRIPTION
CR	Chrome Plating
TG	Thread Guard (Bearing Type Wheels only)
FLB	Front Lock Brake
TLB	Top Lock Brake
ZA	Zerk Axle and NUT
ZS	Zerk fitting on Swivel Raceway

Add Option Code to end of part number.

Wheel Diameter	Tread Width	Wheel Type	Swivel Number	Rigid Number	Wheel Bearing	Load Capacity	Overall Height	Swivel Radius	
3	1-1/4	Mirage (TPR)	TP5230-**-MIR	TP5230R-**-MIR	Precision	225	4-1/8	3	
		Mirage (TPR)	TP5230-**-MIR-CB	TP5230R-**-MIR-CB	Precision	225			
		Mirage (TPR)	TP5230-**-MIR-PB	TP5230R-**-MIR-PB	Plain	225			
		Soft Rubber	TP5230-**-SR	TP5230R-**-SR	Nylon	150			
		Hard Rubber	TP5230-**-HR	TP5230R-**-HR	Nylon	220			
		Hard Rubber	TP5230-**-HRB	TP5230R-**-HRB	Ball	220			
	1-15/32	Light Duty Plastic	TP5230-**-LDP	TP5230R-**-LDP	Plain	250			
		Heavy Duty Plastic	TP5230-**-HDP	TP5230R-**-HDP	Plain	300			
		Heavy Duty Plastic	TP5230-**-HPB	TP5230R-**-HPB	Ball	300			
		Steel	TP5230-**-STL	TP5230R-**-STL	Plain	300			
		1-1/4	Polyurethane	TP5230-**-PLY	TP5230R-**-PLY	Ball			250
			Polyurethane	TP5230-**-PLY-CB	TP5230R-**-PLY-CB	Precision			250
			Polyurethane	TP5230-**-PLY-PB	TP5230R-**-PLY-PB	Plain			250
			Solid Polyurethane	TP5230-**-PLX-PB	TP5230R-**-PLX-PB	Plain			250
High Elastic Polyurethane	TP5230-**-PLE		TP5230R-**-PLE	Precision	125				
Phenolic	TP5230-**-PHN-PB		TP5230R-**-PHN-PB	Plain	300				
Fever Nylon Hi-Temp	TP5230-**-FVR-PB	TP5230R-**-FVR-PB	Plain	300					
3-1/2	1-1/4	Mirage (TPR)	TP5235-**-MIR	TP5235R-**-MIR	Precision	250	4-5/8	3-1/4	
		Mirage (TPR)	TP5235-**-MIR-CB	TP5235R-**-MIR-CB	Precision	250			
		Polyurethane	TP5235-**-PLY-CB	TP5235R-**-PLY-CB	Precision	250			
4	1-1/4	Mirage (TPR)	TP5240-**-MIR	TP5240R-**-MIR	Precision	275	5-1/8	3-1/2	
		Mirage (TPR)	TP5240-**-MIR-CB	TP5240R-**-MIR-CB	Precision	275			
		Mirage (TPR)	TP5240-**-MIR-PB	TP5240R-**-MIR-PB	Plain	275			
		Soft Rubber	TP5240-**-SR	TP5240R-**-SR	Nylon	175			
		Hard Rubber	TP5240-**-HR	TP5240R-**-HR	Nylon	255			
		Hard Rubber	TP5240-**-HRB	TP5240R-**-HRB	Ball	255			
		Polyurethane	TP5240-**-PLY	TP5240R-**-PLY	Ball	280			
		Polyurethane	TP5240-**-PLY-CB	TP5240R-**-PLY-CB	Precision	280			
		Polyurethane	TP5240-**-PLY-PB	TP5240R-**-PLY-PB	Plain	280			
	1-15/32	Solid Polyurethane	TP5240-**-PLX-PB	TP5240R-**-PLX-PB	Plain	300			
		High Elastic Polyurethane	TP5240-**-PLE	TP5240R-**-PLE	Precision	165			
		Light Duty Plastic	TP5240-**-LDP	TP5240R-**-LDP	Plain	270			
	1-1/2	Heavy Duty Plastic	TP5240-**-HDP	TP5240R-**-HDP	Plain	300			
		Heavy Duty Plastic	TP5240-**-HPB	TP5240R-**-HPB	Ball	300			
		Steel	TP5240-**-STL	TP5240R-**-STL	Plain	300			
		Phenolic	TP5240-**-PHN	TP5240R-**-PHN	Roller	300			
		Phenolic	TP5240-**-PHN-PB	TP5240R-**-PHN-PB	Plain	300			
		Phenolic Hi-Temp	TP5240-**-PHN-HT	TP5240R-**-PHN-HT	Roller	300			
Phenolic Hi-Temp		TP5240-**-PHN-PB-HT	TP5240R-**-PHN-PB-HT	Plain	300				
Fever Nylon Hi-Temp		TP5240-**-FVR	TP5240R-**-FVR	Roller	300				
Fever Nylon Hi-Temp		TP5240-**-FVR-PB	TP5240R-**-FVR-PB	Plain	300				
Fever Nylon Hi-Temp	TP5240-**-FVT-BB	TP5240R-**-FVT-BB	Ball Bearing	300					
5	1-1/4	Mirage (TPR)	TP5250-**-MIR	TP5250R-**-MIR	Precision	300	6-1/4	4	
		Mirage (TPR)	TP5250-**-MIR-CB	TP5250R-**-MIR-CB	Precision	300			
		Mirage (TPR)	TP5250-**-MIR-PB	TP5250R-**-MIR-PB	Plain	300			
		Mirage (TPR)	TP5250-**-MRC-CB	TP5250R-**-MRC-CB	Precision	300			
		Soft Rubber	TP5250-**-SR	TP5250R-**-SR	Nylon	200			
		Soft Rubber	TP5250-**-SRB	TP5250R-**-SRB	Ball	200			
		Hard Rubber	TP5250-**-HR	TP5250R-**-HR	Nylon	280			
		Hard Rubber	TP5250-**-HRB	TP5250R-**-HRB	Ball	280			
		Polyurethane	TP5250-**-PLY	TP5250R-**-PLY	Ball	300			
		Polyurethane	TP5250-**-PLY-CB	TP5250R-**-PLY-CB	Precision	300			
	1-15/32	Polyurethane	TP5250-**-PLY-PB	TP5250R-**-PLY-PB	Plain	300			
		Solid Polyurethane	TP5250-**-PLX-PB	TP5250R-**-PLX-PB	Plain	350			
		High Elastic Polyurethane	TP5250-**-PLE	TP5250R-**-PLE	Precision	175			
		Heavy Duty Plastic	TP5250-**-HDP	TP5250R-**-HDP	Plain	350			
		Heavy Duty Plastic	TP5250-**-HPB	TP5250R-**-HPB	Ball	350			
		Phenolic	TP5250-**-PHN	TP5250R-**-PHN	Roller	350			
1-1/2	Phenolic	TP5250-**-PHN-PB	TP5250R-**-PHN-PB	Plain	350				
	Fever Nylon Hi-Temp	TP5250-**-FVR	TP5250R-**-FVR	Roller	350				
	Fever Nylon Hi-Temp	TP5250-**-FVR-PB	TP5250R-**-FVR-PB	Plain	350				
	Fever Nylon Hi-Temp	TP5250-**-FVR-PB	TP5250R-**-FVR-PB	Plain	350				
6	1-1/4	Mirage (TPR)	TP5260-**-MIR-CB	TP5260R-**-MIR-CB	Precision	300			
		Mirage (TPR)	TP5260-**-MIR-PB	TP5260R-**-MIR-PB	Plain	300			
		Soft Rubber	TP5260-**-SRB	TP5260R-**-SRB	Ball	220			
		Hard Rubber	TP5260-**-HRB	TP5260R-**-HRB	Ball	300			
		Polyurethane	TP5260-**-PLY	TP5260R-**-PLY	Ball	350			
	Polyurethane	TP5260-**-PLY-CB	TP5260R-**-PLY-CB	Precision	350				
	1-15/32	Heavy Duty Plastic	TP5260-**-HPB	TP5260R-**-HPB	Ball	360			
	1-1/2	Phenolic	TP5260-**-PHN	TP5260R-**-PHN	Roller	360			

Light-Medium Duty Food Service Casters

Caster Selection Guide for TP5200 Series



TP5250-01-PLY-CB-F/TG (MAROON)



TP5235-02-PLY-CB-FLB



TP5240-03-FVR-ZS-ZA



TP5250-01-PLX-PB



TP5250-01-PLY-CB



TP5250R-01-MIR



TP5252R-02-HDP-F
(U-Bracket Type)

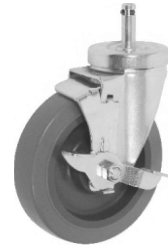

TP5250-11-MIR-TLB
7/16 X 1-3/8"

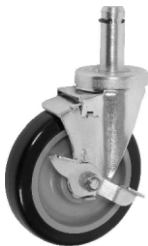

TP5250-12-PLY-TLB
0.845 X 2"



TP5250-22-MIR-F/TG-FLB
1/2-13 x 1-1/2"



TP5250-28-HDP-F
5/8-11 x 1"



TP5250-76-MIR-CB
(Rubber Expanding Adapter)



TP5250-33-PLY-CB
(Hand Truck Caster)



TP5250-51-PRO-DB-ZS-ZA
(0.845 x 2-1/2")



TP5250-52-PLY-CB
7/8 X 2-1/2"



TP5250RU-12-PLY-CB-F/TG
0.845 X 2"

Light-Medium Duty Food Service Casters

TP5400 Series / Capacity up to 300 Lbs.



Features

- **Finish** :Bright zinc plating
- **Swivel** :Double ball bearing raceways
Upper and lower caps have seal which helps protect bearings.
- **Rigid** : Not available
- **Construction** : Heavy duty gauge steel formed for extra strength
- **Axle** : 3/8" diameter axle with lock nut

Applications

- Food Service Equipment
- Institutional, Hotel & Hospital Equipment
- Laboratory Equipment
- L/M duty Material Handling Equipment
- Office & Store Fixtures

Caster Options

- TLB: Top Lock Brake



TP5400 Series

Wheel Diameter	Tread Width	Wheel Type	Swivel Number	Wheel Bearing	Load Capacity	Overall Height	Swivel Radius
3	1-1/4	Mirage (TPR)	TP5430-**-MIR	Precision	225	3-25/32	2-5/8
		Mirage (TPR)	TP5430-**-MIR-CB	Precision	225		
		Mirage (TPR)	TP5430-**-MIR-PB	Plain	225		
		Soft Rubber	TP5430-**-SR	Nylon	150		
		Hard Rubber	TP5430-**-HR	Nylon	220		
		Hard Rubber	TP5430-**-HRB	Ball	220		
	1-3/8	Light Duty Plastic	TP5430-**-LDP	Plain	250		
		Heavy Duty Plastic	TP5430-**-HDP	Plain	300		
		Polyurethane	TP5430-**-PLY	Ball	250		
		Polyurethane	TP5430-**-PLY-CB	Precision	250		
Polyurethane	TP5430-**-PLY-PB	Plain	250				
4	1-1/4	Mirage (TPR)	TP5440-**-MIR	Precision	250	5-5/32	3-5/32
		Mirage (TPR)	TP5440-**-MIR-CB	Precision	250		
		Mirage (TPR)	TP5440-**-MIR-PB	Plain	250		
		Soft Rubber	TP5440-**-SR	Nylon	175		
		Hard Rubber	TP5440-**-HR	Nylon	255		
		Hard Rubber	TP5440-**-HRB	Ball	255		
		Polyurethane	TP5440-**-PLY	Ball	280		
		Polyurethane	TP5440-**-PLY-CB	Precision	280		
		Polyurethane	TP5440-**-PLY-PB	Plain	280		
	Light Duty Plastic	TP5440-**-LDP	Plain	225			
1-15/32	Heavy Duty Plastic	TP5440-**-HDP	Plain	275			
5	1-1/4	Mirage (TPR)	TP5450-**-MIR	Precision	300	5-27/32	3-11/16
		Mirage (TPR)	TP5450-**-MIR-CB	Precision	300		
		Mirage (TPR)	TP5450-**-MIR-PB	Plain	300		
		Soft Rubber	TP5450-**-SR	Nylon	200		
		Hard Rubber	TP5450-**-HR	Nylon	280		
		Hard Rubber	TP5450-**-HRB	Ball	280		
		Polyurethane	TP5450-**-PLY	Ball	300		
		Polyurethane	TP5450-**-PLY-CB	Precision	300		
		Polyurethane	TP5450-**-PLY-PB	Plain	300		
	1-15/32	Heavy Duty Plastic	TP5450-**-HDP	Plain	300		

Fastenings

TYPE	CODE	SIZE (Inch)	
Top Plate	03	Overall Size	3-1/8 x 4-1/8
		Bolt Hole Spacing	1-3/4 x 3 slotted to 2-3/8 x 3-3/8
		Attaching Bolt Size	5/16
Grip Ring	11	7/16 x 1-1/2	

Options

CODE	DESCRIPTION
CR	Chrome Plating
TLB	Top Lock Brake
TG	Thread Guard (Bearing Type Wheels Only)

Add Option Code to end of part number.

Replace -**- in part number with appropriate fastening code.

Light-Medium Duty Total Lock Casters

TP5300 Series / Capacity up to 350 Lbs.



Features

- **Finish:** Bright zinc plating
- **Swivel:** Double ball bearing raceways
- **SWB:** Metal Pedal Total Lock Brake available
- **Construction:** Heavy duty gauge steel formed for extra strength
- **Axle:** 3/8" diameter axle with lock nut
- **Applicators:** Rubber Expanding Adapters Stems available

Applications

- Bakery & Food Service Equipment
- Institutional, Hotel & Hospital Equipment
- Laboratory Equipment
- Material Handling Equipment
- Moving Dollies
- Office & Store Fixtures
- Utility & Maintenance Carts

Caster Options

- SWB: Metal Pedal Total Lock Brake



- Swivel



- REA: Rubber Expanding Adapter



- Rigid



Fastenings			
TYPE	CODE	SIZE (Inch)	
Top Plate	01	Overall Size	Small 2-3/8 x 3-5/8
		Bolt Hole Spacing	1-3/4 x 2-7/8 slotted to 3
		Attaching Bolt Size	5/16
	02	Overall Size	Medium 3-1/8 x 4-1/8
		Bolt Hole Spacing	1-3/4 x 2-15/16 slotted to 2-3/8 x 3-3/8
		Attaching Bolt Size	5/16
	03	Overall Size	Large' 3-3/4 x 4-1/2
		Bolt Hole Spacing	2-5/8 x 3-5/8 slotted to 3 x 3
		Attaching Bolt Size	3/8
Grip Ring	12	0.845 x 2-3/16	
Threaded Stem	21	1/2 - 13 x 1	
	22	1/2 - 13 x 1-1/2	
	23	1/2 - 13 x 2	
	24	1/2 - 13 x 2-1/2	
	26	1/2 - 13 x 2-3/4 (threaded 1-1/2" from top)	
Rubber Expanding Adapter	CODE	ID of Tube	Size Range
	71	3/4"	0.720" ~ 0.851"
	72	7/8"	0.852" ~ 0.927"
	72A	1"	0.928" ~ 1.029"
	73	1-1/8"	1.030" ~ 1.140"
	74	1-3/16"	1.178" ~ 1.303"
	75	1-3/8"	1.360" ~ 1.425"
	76	1-1/2"	1.426" ~ 1.589"
77	1-3/4"	1.685" ~ 1.80"	

Options	
CODE	DESCRIPTION
TG	Thread Guard (Bearing Type Wheels Only)
SWB	Metal Pedal Total Lock Brake

Add Option Code to end of part number.

Replace -* *- in part number with appropriate fastening code.

Light-Medium Duty Total Lock Casters

TP5300 Series

Wheel Diameter	Tread Width	Wheel Type	Swivel Number	Rigid Number	Wheel Bearing	Load Capacity	Overall Height	Swivel Radius
3	1-1/4	Mirage (TPR)	TP5330-**-MIR	TP5330R-**-MIR	Precision	225	4-1/8	4-5/32
		Mirage (TPR)	TP5330-**-MIR-CB	TP5330R-**-MIR-CB	Precision	225		
		Mirage (TPR)	TP5330-**-MIR-PB	TP5330R-**-MIR-PB	Plain	225		
	1-3/8	Heavy Duty Plastic	TP5330-**-HDP	TP5330R-**-HDP	Plain	300		
		Steel	TP5330-**-STL	TP5330R-**-STL	Plain	300		
	1-1/4	Polyurethane	TP5330-**-PLY	TP5330R-**-PLY	Ball	250		
		Polyurethane	TP5330-**-PLY-CB	TP5330R-**-PLY-CB	Precision	250		
		Polyurethane	TP5330-**-PLY-PB	TP5330R-**-PLY-PB	Plain	250		
3-1/2	1-1/4	Mirage (TPR)	TP5335-**-MIR	TP5335R-**-MIR	Precision	250	4-5/8	4-5/32
		Mirage (TPR)	TP5335-**-MIR-CB	TP5335R-**-MIR-CB	Precision	250		
		Polyurethane	TP5335-**-PLY-CB	TP5335R-**-PLY-CB	Precision	250		
4	1-1/4	Mirage (TPR)	TP5340-**-MIR	TP5340R-**-MIR	Annular	250	5-1/8	4-5/32
		Mirage (TPR)	TP5340-**-MIR-CB	TP5340R-**-MIR-CB	Precision	250		
		Mirage (TPR)	TP5340-**-MIR-PB	TP5340R-**-MIR-PB	Plain	250		
		Polyurethane	TP5340-**-PLY	TP5340R-**-PLY	Ball	280		
		Polyurethane	TP5340-**-PLY-CB	TP5340R-**-PLY-CB	Precision	280		
		Polyurethane	TP5340-**-PLY-PB	TP5340R-**-PLY-PB	Plain	280		
	1-15/32	Solid Polyurethane	TP5340-**-PLX-PB	TP5340R-**-PLX-PB	Plain	300		
		Heavy Duty Plastic	TP5340-**-HDP	TP5340R-**-HDP	Plain	300		
	1-1/4	Steel	TP5340-**-STL	TP5340R-**-STL	Plain	300		
		Phenolic	TP5340-**-PHN-PB	TP5340R-**-PHN-PB	Plain	300		
		Phenolic Hi-Temp	TP5340-**-PHN-HT	TP5340R-**-PHN-HT	Roller	300		
		Phenolic Hi-Temp	TP5340-**-PHN-PB-HT	TP5340R-**-PHN-PB-HT	Plain	300		
		Fever Nylon Hi-Temp	TP5340-**-FVR-PB	TP5340R-**-FVR-PB	Plain	300		
		Fever-Tech Epoxy Hi-Temp	TP5340-**-FVT	TP5340R-**-FVT	Precision Ball	300		
5	1-1/4	Mirage (TPR)	TP5350-**-MIR	TP5350R-**-MIR	Precision	300	6-1/4	4-5/32
		Mirage (TPR)	TP5350-**-MIR-CB	TP5350R-**-MIR-CB	Precision	300		
		Mirage (TPR)	TP5350-**-MIR-PB	TP5350R-**-MIR-PB	Plain	300		
		Polyurethane	TP5350-**-PLY	TP5350R-**-PLY	Ball	300		
		Polyurethane	TP5350-**-PLY-CB	TP5350R-**-PLY-CB	Precision	300		
		Polyurethane	TP5350-**-PLY-PB	TP5350R-**-PLY-PB	Plain	300		
		Solid Polyurethane	TP5350-**-PLX-PB	TP5350R-**-PLX-PB	Plain	350		
	1-15/32	Heavy Duty Plastic	TP5350-**-HDP	TP5350R-**-HDP	Plain	350		
		Phenolic	TP5350-**-PHN-PB	TP5350R-**-PHN-PB	Plain	350		
		Fever Nylon Hi-Temp	TP5350-**-FVR-PB	TP5350R-**-FVR-PB	Plain	350		

Wheel Options

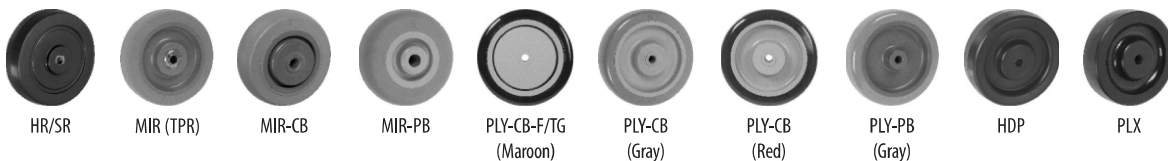

Caster Selection Guide



Medium Duty Casters

TP6200 Series / Capacity up to 550 Lbs. each



Features

- **Finish:** Bright zinc plating
- **Swivel:** Double ball bearing with hardened raceways for extra strength
- **Rigid:** Welded with heavy duty gauge steel for extra strength
- **Fork Leg Spacing:** 2"
- **Grease Fittings:** Grease hole in lower raceway cup
- **Axle:** 1/2" diameter zerkl axle with lock nut

Applications

- Medium Duty Platform Truck
- Bread Racks
- Food Service Equipment
- Warehouse Carts

Caster Options

- TLB: Top Lock Brake



- Rigid

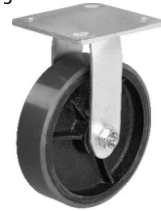

TP6200 Series

Wheel Diameter	Tread Width	Wheel Type	Swivel Number	Rigid Number	Wheel Bearing	Load Capacity	Overall Height	Swivel Radius
4	1-1/2	Fever Hi-Temp	TP6240-**-FVR	TP6240R-**-FVR	Roller	400	5-5/16	3-3/8
		Heavy Duty Plastic	TP6240-**-HPB	TP6240R-**-HPB	Ball	450		
		Polyurethane / Cast Iron	TP6240-**-PCI	TP6240R-**-PCI	Roller	450		
		Phenolic	TP6240-**-PHN	TP6240R-**-PHN	Roller	450		
		Phenolic	TP6240-**-PHN-HT	TP6240R-**-PHN-HT	Roller	450		
		Pro-Tech Polyurethane Rubber / Cast Iron	TP6240-**-PRO	TP6240R-**-PRO	Roller	450		
		Rubber / Cast Iron	TP6240-**-RCI	TP6240R-**-RCI	Roller	250		
5	1-1/2	Fever Hi-Temp	TP6250-**-FVR	TP6250R-**-FVR	Roller	500	6-5/16	4-1/8
		Heavy Duty Plastic	TP6250-**-HPB	TP6250R-**-HPB	Ball	500		
		Polyurethane / Cast Iron	TP6250-**-PCI	TP6250R-**-PCI	Roller	500		
		Phenolic	TP6250-**-PHN	TP6250R-**-PHN	Roller	500		
		Pro-Tech Polyurethane	TP6250-**-PRO	TP6250R-**-PRO	Roller	500		
		Rubber / Cast Iron	TP6250-**-RCI	TP6250R-**-RCI	Roller	350		
6	1-1/2	Fever Hi-Temp	TP6260-**-FVR	TP6260R-**-FVR	Roller	500	7-1/2	4-5/8
		Heavy Duty Plastic	TP6260-**-HPB	TP6260R-**-HPB	Ball	500		
		Polyurethane / Cast Iron	TP6260-**-PCI	TP6260R-**-PCI	Roller	550		
		Phenolic	TP6260-**-PHN	TP6260R-**-PHN	Roller	500		
		Polyurethane / Cast Iron	TP6260-**-PCI	TP6260R-**-PCI	Roller	550		
		Rubber / Cast Iron	TP6260-**-RCI	TP6260R-**-RCI	Roller	450		

Fastenings

TYPE	CODE	SIZE (Inch)	
Top Plate	02	Overall Size	4 x 4-1/2
		Bolt Hole Spacing	2-5/8 x 3-5/8 slotted to 3 x 3
		Attaching Bolt Size	3/8
Threaded Stem	21	5/8 - 11 x 2	

Options

CODE	DESCRIPTION
TLB	Top Lock Brake
TG	Thread Guard

Add Option Code to end of part number.

Wheel Options



Medium Duty Casters

TP6400 Series / Capacity up to 800 Lbs.



Features

- **Finish:** Bright zinc plating
- **Swivel:** Double ball bearing with hardened raceways for extra strength
- **Rigid:** Welded with heavy duty gauge steel for extra strength
- **Fork Leg Spacing:** 2"
- **Grease Fittings:** Provided in swivel raceway and wheel bearings
- **Axle:** 1/2" diameter zerkl axle with lock nut

Applications

- Food Service Equipment
- Medium Duty Appliances
- Medium Duty Platform Truck
- Warehouse Stock Carts
- Wire Shelving Units

Caster Options

- TLB: Top Lock Brake



- Rigid



Wheel Diameter	Tread Width	Wheel Type	Swivel Number	Rigid Number	Wheel Bearing	Load Capacity	Overall Height	Swivel Radius
4	1-1/2	Solid Polyurethane	TP6440-**-PLX	TP6440R-**-PLX	Roller	600	5-5/8	3-9/16
		Polyurethane / Cast Iron	TP6440-**-PCI	TP6440R-**-PCI	Roller	600		
		Heavy Duty Plastic	TP6440-**-HPB	TP6440R-**-HPB	Ball	500		
		Fever Hi-Temp	TP6440-**-FVR	TP6440R-**-FVR	Roller	600		
		Phenolic	TP6440-**-PHN	TP6440R-**-PHN	Roller	600		
		Hi-Temp Phenolic	TP6440-**-PHN-HT	TP6440R-**-PHN-HT	Roller	600		
		Pro-Tech Polyurethane Rubber / Cast Iron	TP6440-**-PRO	TP6440R-**-PRO	Roller	500		
			TP6440-**-RCI	TP6440R-**-RCI	Roller	250		
5	1-1/2	Solid Polyurethane	TP6450-**-PLX	TP6450R-**-PLX	Roller	700	6-1/2	4-1/4
		Polyurethane / Cast Iron	TP6450-**-PCI	TP6450R-**-PCI	Roller	700		
		Heavy Duty Plastic	TP6450-**-HPB	TP6450R-**-HPB	Ball	700		
		Fever Hi-Temp	TP6450-**-FVR	TP6450R-**-FVR	Roller	700		
		Phenolic	TP6450-**-PHN	TP6450R-**-PHN	Roller	700		
		Pro-Tech Polyurethane	TP6450-**-PRO	TP6450R-**-PRO	Roller	600		
		Rubber / Cast Iron	TP6450-**-RCI	TP6450R-**-RCI	Roller	350		
6	1-1/2	Solid Polyurethane	TP6460-**-PLX	TP6460R-**-PLX	Roller	800	7-3/8	5
		Polyurethane / Cast Iron	TP6460-**-PCI	TP6460R-**-PCI	Roller	800		
		Heavy Duty Plastic	TP6460-**-HPB	TP6460R-**-HPB	Ball	800		
		Fever Hi-Temp	TP6460-**-FVR	TP6460R-**-FVR	Roller	800		
		Phenolic	TP6460-**-PHN	TP6460R-**-PHN	Roller	800		
		Pro-Tech Polyurethane	TP6460-**-PRO	TP6460R-**-PRO	Roller	700		
		Rubber / Cast Iron	TP6460-**-RCI	TP6460R-**-RCI	Roller	450		

Fastenings

TYPE	CODE	SIZE (Inch)	
Top Plate	01	Overall Size	4 x 4-1/2
		Bolt Hole Spacing	2-5/8 x 3-5/8 slotted to 3 x 3
		Attaching Bolt Size	3/8

Options

CODE	DESCRIPTION
TLB	Top Lock Brake
PSL	4 Position Swivel Lock
TG	Thread Guard (Bearing Type Wheels)

Replace -**- in part number with appropriate fastening code.

Add Option Code to end of part number.

Wheel Options



RCI

PCI

PRO (RED)

PRO (MAROON)

PHN

FVR-4K7-F

PLX

Medium-Heavy Duty Casters

TP6600 Series / Capacity up to 1250 Lbs.



NSF

Features

- **Finish:** Bright zinc plating
- **Swivel:** Double ball bearings with hardened raceways for extra strength
- **Rigid:** Welded with heavy duty gauge steel for extra strength
- **Fork Leg Spacing:** 2-1/2"
- **Construction:** 1/4" thick top plate and legs for additional strength
- **King Pin:** 5/8" diameter bolt and nut
- **Grease Fittings:** Provided in swivel raceway and wheel bearings
- **PSL-Notched:** All swivel rigs notched for optional 4-Position swivel lock
- **Axle:** 1/2" diameter axle with lock nut

Applications

- Material Handling
- Mobile Storage Racks
- Mobile Tool Chests
- Platform Carts
- Warehouse Trucks

Caster Options

- TLB: Top Lock Brake



- M/SWB: Metal Pedal Total Lock Brake



- FLB: Front Lock Brake



- CLB: Cam Lock Brake



Fastenings			
TYPE	CODE	SIZE (Inch)	
Top Plate	01	Overall Size	4 x 4-1/2
		Bolt Hole Spacing	2-5/8 x 3-5/8 slotted to 3 x 3
		Attaching Bolt Size	3/8
	04	Overall Size	5 x 5-1/2
		Bolt Hole Spacing	4-1/8 x 4-1/2
		Attaching Bolt Size	3/8"
	07	Overall Size	4-1/2 x 6-1/4
		Bolt Hole Spacing	2-7/16 x 4-15/16 slotted to 3-3/8 x 5-1/4
		Attaching Bolt Size	1/2"
Threaded Stem	23	3/4-10 x 1-1/2 (6" Only)	

Replace -* *- in part number with appropriate fastening code.

Options

CODE	DESCRIPTION
TLB	Heavy Duty Top Lock Brake
M/SWB	Metal Pedal Total Lock Brake
SWB	Swivel and Wheel Brake
FLB	Front Lock Brake
CLB	Cam Lock Brake
RLB	Rigid Lock Brake (TP6680R & TP6680 Only)
DB	Delrin Bearing
BB	Ball Bearing
PBB	Precision Ball Bearing
PSL	4 Position Swivel Lock
SL	Sealed Swivel
TG	Thread Guard
F	Flanged Metal Washer

Add Option Code to end of part number.

- Rigid



- RLB: Rigid Lock Brake



- PSL-4: O-Ring

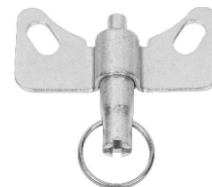

- BX : Black Oxide



TP6600 Series

Medium-Heavy Duty Casters

TP6600 Series / Capacity up to 1250 Lbs.

Wheel Diameter	Tread Width	Wheel Type	Swivel Number	Rigid Number	Wheel Bearing	Load Capacity	Overall Height	Swivel Radius
4	2	Fever Hi-Temp	TP6640-**-FVR	TP6640R-**-FVR	Roller	800	5-5/8	3-9/16
		Heavy Duty Plastic	TP6640-**-HDP	TP6640R-**-HDP	Plain	550		
		Heavy Duty Plastic	TP6640-**-HPR	TP6640R-**-HPR	Roller	550		
		Heavy Duty Plastic	TP6640-**-HPR-DB	TP6640R-**-HPR-DB	Delrin	550		
		Mirage (TPR)	TP6640-**-MIR	TP6640R-**-MIR	Roller	350		
		Crown Mirage (TPR)	TP6640-**-MRC	TP6640R-**-MRC	Roller	350		
		Nylon Glass-Filled	TP6640-**-NGF	TP6640R-**-NGF	Roller	800		
		Polyurethane / Aluminum	TP6640-**-PAL	TP6640R-**-PAL	Roller	700		
		Polyurethane / Cast Iron	TP6640-**-PCI	TP6640R-**-PCI	Roller	700		
		Crown Polyurethane / Cast Iron	TP6640-**-PCC	TP6640R-**-PCC	Roller	600		
		Crown Polyurethane / Cast Iron	TP6640-**-PCC-PBB	TP6640R-**-PCC-PBB	Precision	600		
		Solid Polyurethane	TP6640-**-PLX	TP6640R-**-PLX	Roller	700		
		Solid Polyurethane	TP6640-**-PLX-DB	TP6640R-**-PLX-DB	Delrin	700		
		Solid Polyurethane	TP6640-**-PLX-PBB	TP6640R-**-PLX-PBB	Precision	700		
		Polyurethane / Nylon	TP6640-**-PNY	TP6640R-**-PNY	Roller	700		
		Pro-Tech Polyurethane	TP6640-**-PRO	TP6640R-**-PRO	Roller	700		
		Pro-Tech Polyurethane	TP6640-**-PRO-DB	TP6640R-**-PRO-DB	Delrin	700		
		Pro-Tech Polyurethane	TP6640-**-PRO-PBB	TP6640R-**-PRO-PBB	Precision	700		
		Pro-Tech Extra	TP6640-**-PRX-PBB	TP6640R-**-PRX-PBB	Precision	600		
		Phenolic	TP6640-**-PHN	TP6640R-**-PHN	Roller	800		
		Phenolic	TP6640-**-PHN-DB	TP6640R-**-PHN-DB	Delrin	800		
		Phenolic	TP6640-**-PHN-PBB	TP6640R-**-PHN-PBB	Precision	800		
		Hi-Temp Phenolic	TP6640-**-PHN-HT	TP6640R-**-PHN-HT	Roller	800		
		Rubber / Aluminum	TP6640-**-RAL	TP6640R-**-RAL	Roller	250		
Rubber / Cast Iron	TP6640-**-RCI	TP6640R-**-RCI	Roller	400				
Rubber / Cast Iron	TP6640-**-RNY	TP6640R-**-RNY	Roller	400				
Steel	TP6640-**-STL	TP6640R-**-STL	Roller	700				
Ductile Iron	TP6640-**-SDI	TP6640R-**-SDI	Roller	1000				
V-Groove Steel	TP6640-**-VGR	TP6640R-**-VGR	Roller	700				
5	2	Fever Hi-Temp	TP6650-**-FVR	TP6650R-**-FVR	Roller	1000	6-1/2	4-1/4
		Heavy Duty Plastic	TP6650-**-HDP	TP6650R-**-HDP	Plain	650		
		Heavy Duty Plastic	TP6650-**-HPR	TP6650R-**-HPR	Roller	650		
		Heavy Duty Plastic	TP6650-**-HPR-DB	TP6650R-**-HPR-DB	Delrin	650		
		Mirage (TPR)	TP6650-**-MIR	TP6650R-**-MIR	Roller	400		
		Crown Mirage (TPR)	TP6650-**-MRC	TP6650R-**-MRC	Roller	400		
		Nylon Glass-Filled	TP6650-**-NGF	TP6650R-**-NGF	Roller	1000		
		Nylon	TP6650-**-NYL	TP6650R-**-NYL	Roller	700		
		Nylon	TP6650-**-NYL-DB	TP6650R-**-NYL-DB	Delrin	700		
		Nylon	TP6650-**-NYL-PBB	TP6650R-**-NYL-PBB	Precision	700		
		Polyurethane / Aluminum	TP6650-**-PAL	TP6650R-**-PAL	Roller	1000		
		Polyurethane / Cast Iron	TP6650-**-PCI	TP6650R-**-PCI	Roller	1000		
		Crown Polyurethane / Cast Iron	TP6650-**-PCC	TP6650R-**-PCC	Roller	800		
		Crown Polyurethane / Cast Iron	TP6650-**-PCC-PBB	TP6650R-**-PCC-PBB	Precision	800		
		Solid Polyurethane	TP6650-**-PLX	TP6650R-**-PLX	Roller	800		
		Solid Polyurethane	TP6650-**-PLX-DB	TP6650R-**-PLX-DB	Delrin	800		
		Solid Polyurethane	TP6650-**-PLX-PBB	TP6650R-**-PLX-PBB	Precision	800		
		Polyurethane / Nylon	TP6650-**-PNY	TP6650R-**-PNY	Roller	1000		
		Pro-Tech Polyurethane	TP6650-**-PRO	TP6650R-**-PRO	Roller	750		
		Pro-Tech Polyurethane	TP6650-**-PRO-DB	TP6650R-**-PRO-DB	Delrin	750		
		Pro-Tech Polyurethane	TP6650-**-PRO-PBB	TP6650R-**-PRO-PBB	Precision	750		
		Pro-Tech Extra	TP6650-**-PRX-PBB	TP6650R-**-PRX-PBB	Precision	800		
		Phenolic	TP6650-**-PHN	TP6650R-**-PHN	Roller	1000		
		Phenolic	TP6650-**-PHN-DB	TP6650R-**-PHN-DB	Delrin	1000		
Phenolic	TP6650-**-PHN-PBB	TP6650R-**-PHN-PBB	Precision	1000				
Hi-Temp Phenolic	TP6650-**-PHN-HT	TP6650R-**-PHN-HT	Roller	1000				
Rubber / Aluminum	TP6650-**-RAL	TP6650R-**-RAL	Roller	500				
Rubber / Cast Iron	TP6650-**-RCI	TP6650R-**-RCI	Roller	450				
Rubber / Nylon	TP6650-**-RNY	TP6650R-**-RNY	Roller	450				
Steel	TP6650-**-STL	TP6650R-**-STL	Roller	1000				
Ductile Iron	TP6650-**-SDI	TP6650R-**-SDI	Roller	1250				
V-Groove Steel	TP6650-**-VGR	TP6650R-**-VGR	Roller	900				

TP6600 Series

TP6600 Series / Capacity up to 1250 Lbs.

Wheel Diameter	Tread Width	Wheel Type	Swivel Number	Rigid Number	Wheel Bearing	Load Capacity	Overall Height	Swivel Radius
6	2	Air / Flat Free	TP6660-**-AFR-BB	TP6660R-**-AFR-BB	Ball	250	7-1/2	4-1/2
		Fever Hi-Temp	TP6660-**-FVR	TP6660R-**-FVR	Roller	1200		
		Heavy Duty Plastic	TP6660-**-HDP	TP6660R-**-HDP	Plain	700		
		Heavy Duty Plastic	TP6660-**-HPR	TP6660R-**-HPR	Roller	700		
		Heavy Duty Plastic	TP6660-**-HPR-DB	TP6660R-**-HPR-DB	Delrin	700		
		Mirage (TPR)	TP6660-**-MIR	TP6660R-**-MIR	Roller	500		
		Crown Mirage (TPR)	TP6660-**-MRC	TP6660R-**-MRC	Roller	500		
		Nylon Glass-Filled	TP6660-**-NGF	TP6660R-**-NGF	Roller	1200		
		Nylon	TP6660-**-NYL	TP6660R-**-NYL	Roller	800		
		Nylon	TP6660-**-NYL-DB	TP6660R-**-NYL-DB	Delrin	800		
		Nylon	TP6660-**-NYL-PBB	TP6660R-**-NYL-PBB	Precision	800		
		Polyurethane / Aluminum	TP6660-**-PAL	TP6660R-**-PAL	Roller	1200		
		Crown Polyurethane / Aluminum	TP6660-**-Palc-PBB	TP6660R-**-Palc-PBB	Precision	1200		
		Polyurethane / Cast Iron	TP6660-**-PCI	TP6660R-**-PCI	Roller	1200		
		Crown Polyurethane / Cast Iron	TP6660-**-PCC	TP6660R-**-PCC	Roller	900		
		Crown Polyurethane / Cast Iron	TP6660-**-PCC-PBB	TP6660R-**-PCC-PBB	Precision	900		
		Polyurethane / Cast Iron Solid	TP6660-**-PCIS-PBB	TP6660R-**-PCIS-PBB	Precision	1250		
		Solid Polyurethane	TP6660-**-PLX	TP6660R-**-PLX	Roller	900		
		Solid Polyurethane	TP6660-**-PLX-DB	TP6660R-**-PLX-DB	Delrin	900		
		Solid Polyurethane	TP6660-**-PLX-PBB	TP6660R-**-PLX-PBB	Precision	900		
		Polyurethane / Nylon	TP6660-**-PNY	TP6660R-**-PNY	Roller	1200		
		Pro-Tech Polyurethane	TP6660-**-PRO	TP6660R-**-PRO	Roller	900		
		Pro-Tech Polyurethane	TP6660-**-PRO-DB	TP6660R-**-PRO-DB	Delrin	900		
		Pro-Tech Polyurethane	TP6660-**-PRO-PBB	TP6660R-**-PRO-PBB	Precision	900		
		Pro-Tech Extra	TP6660-**-PRX-PBB	TP6660R-**-PRX-PBB	Precision	1000		
		Phenolic	TP6660-**-PHN	TP6660R-**-PHN	Roller	1200		
		Phenolic	TP6660-**-PHN-DB	TP6660R-**-PHN-DB	Delrin	1200		
		Phenolic	TP6660-**-PHN-PBB	TP6660R-**-PHN-PBB	Precision	1200		
		Hi-Temp Phenolic	TP6660-**-PHN-HT	TP6660R-**-PHN-HT	Roller	1200		
		Rubber / Aluminum	TP6660-**-RAL	TP6660R-**-RAL	Roller	500		
Rubber / Cast Iron	TP6660-**-RCI	TP6660R-**-RCI	Roller	550				
Rubber / Nylon	TP6660-**-RNY	TP6660R-**-RNY	Roller	550				
Steel	TP6660-**-STL	TP6660R-**-STL	Roller	1200				
Ductile Iron	TP6660-**-SDI	TP6660R-**-SDI	Roller	1250				
V-Groove Steel	TP6660-**-VGR	TP6660R-**-VGR	Roller	1000				
8	2	Fever Hi-Temp	TP6680-**-FVR	TP6680R-**-FVR	Roller	1250	9-1/2	6-1/2
		Heavy Duty Plastic	TP6680-**-HDP	TP6680R-**-HDP	Plain	800		
		Heavy Duty Plastic	TP6680-**-HPR	TP6680R-**-HPR	Roller	800		
		Heavy Duty Plastic	TP6680-**-HPR-DB	TP6680R-**-HPR-DB	Delrin	800		
		Mirage (TPR)	TP6680-**-MIR	TP6680R-**-MIR	Roller	600		
		Crown Mirage (TPR)	TP6680-**-MRC	TP6680R-**-MRC	Roller	600		
		Nylon Glass-Filled	TP6680-**-NGF	TP6680R-**-NGF	Roller	1250		
		Nylon	TP6680-**-NYL	TP6680R-**-NYL	Roller	900		
		Nylon	TP6680-**-NYL-DB	TP6680R-**-NYL-DB	Delrin	900		
		Nylon	TP6680-**-NYL-PBB	TP6680R-**-NYL-PBB	Precision	900		
		Polyurethane / Aluminum	TP6680-**-PAL	TP6680R-**-PAL	Roller	1200		
		Crown Polyurethane / Aluminum	TP6680-**-Palc-PBB	TP6680R-**-Palc-PBB	Precision	1250		
		Polyurethane / Cast Iron	TP6680-**-PCI	TP6680R-**-PCI	Roller	1250		
		Crown Polyurethane / Cast Iron	TP6680-**-PCC	TP6680R-**-PCC	Roller	1000		
		Crown Polyurethane / Cast Iron	TP6680-**-PCC-PBB	TP6680R-**-PCC-PBB	Precision	1000		
		Polyurethane / Cast Iron Solid	TP6680-**-PCIS	TP6680R-**-PCIS	Precision	1300		
		Solid Polyurethane	TP6680-**-PLX	TP6680R-**-PLX	Roller	1000		
		Solid Polyurethane	TP6680-**-PLX-DB	TP6680R-**-PLX-DB	Delrin	1000		
		Solid Polyurethane	TP6680-**-PLX-PBB	TP6680R-**-PLX-PBB	Precision	1000		
		Polyurethane / Nylon	TP6680-**-PNY	TP6680R-**-PNY	Roller	1250		
		Pro-Tech Polyurethane	TP6680-**-PRO	TP6680R-**-PRO	Roller	950		
		Pro-Tech Polyurethane	TP6680-**-PRO-DB	TP6680R-**-PRO-DB	Delrin	950		
		Pro-Tech Polyurethane	TP6680-**-PRO-PBB	TP6680R-**-PRO-PBB	Precision	950		
		Pro-Tech Extra	TP6680-**-PRX-PBB	TP6680R-**-PRX-PBB	Precision	1200		
		Phenolic	TP6680-**-PHN	TP6680R-**-PHN	Roller	1250		
		Phenolic	TP6680-**-PHN-DB	TP6680R-**-PHN-DB	Delrin	1250		
		Phenolic	TP6680-**-PHN-PBB	TP6680R-**-PHN-PBB	Precision	1250		
		Hi-Temp Phenolic	TP6680-**-PHN-HT	TP6680R-**-PHN-HT	Roller	1250		
		Rubber / Aluminum	TP6680-**-RAL	TP6680R-**-RAL	Roller	800		
		Rubber / Cast Iron	TP6680-**-RCI	TP6680R-**-RCI	Roller	600		
Rubber / Nylon	TP6680-**-RNY	TP6680R-**-RNY	Roller	600				
Steel	TP6680-**-STL	TP6680R-**-STL	Roller	1250				
Ductile Iron	TP6680-**-SDI	TP6680R-**-SDI	Roller	1250				

TP6600 Series

Medium-Heavy Duty Casters

Wheel Options for TP6600 & TP6800 & 7000 Series



AFR



RCI



RNY



PCI
(GREEN)



PCI
(RED)



PNY



PCC



STL



SDI



MR



MRC



PRX
(RED)



PRX
(BLUE)



PRX(S)
(BLUE)



PALC
(ORANGE)



PALC
(GREEN)



PAL



PRO
(RED)



PRO
(MAROON)



PLX



RAL



RND
(BLACK)



RND
(GRAY)



NGF



RTR



HPR



HDP



PHN



PHN-HT



FVR

TP6600 Series

Pneumatic & Air/Flat Free Casters

TP6600W Series / Capacity up to 500 Lbs.



Features

- **Finish:** Bright zinc plating
- **Swivel:** Double ball bearing raceway
- **Rigid:** Welded with heavy duty gauge steel for extra strength
- **Grease Fittings:** Zerk in swivel section
- **PSL-Notched:** All swivel rigs notched for optional 4-Position swivel lock
- **Axle:** 1/2" diameter axle with lock nut
- **PNU wheel:** 50 Psi for higher load capacity and 4-ply tread, 3piece bolted hub
- Air Free (Flat-Free) wheels available
- Sealed precision ball bearing comes standard all PNU and AFR wheels.
- Inner tube available repair for PNU wheels

Applications

- Film and Entertainment Equipment
- Garden Equipment
- Platform Trucks

Caster Options

- TLB: Top Lock Brake



- PSL: 4-Position Swivel Lock

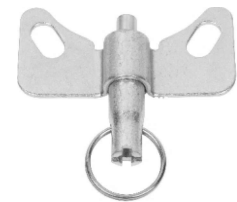

TP6600W Series

Wheel Diameter	Tread Width	Wheel Type	Swivel Number	Rigid Number	Wheel Bearing	Load Capacity	Overall Height	Swivel Radius	Note
8	3	Pneumatic	TP6680W-01-PNU-PBB	TP6680WR-01-PNU-PBB	Precision	275	10	6-3/4	4 ply
10	3-1/2	Pneumatic	TP6610W-01-PNU-PBB	TP6610WR-01-PNU-PBB	Precision	500	12	7-3/4	4 ply
6	2	Air/Flat Free	TP6660-01-AFR-PBB	TP6660R-01-AFR-PBB	Precision	200	7-1/2	4-9/16	
8	3	Air/Flat Free	TP6680W-01-AFR-PBB	TP6680WR-01-AFR-PBB	Precision	275	10	6-3/4	
10	3-1/2	Air/Flat Free	TP6610W-01-AFR-PBB	TP6610WR-01-AFR-PBB	Precision	300	12	7-3/4	

Fastening			
TYPE	CODE	SIZE (Inch)	
Top Plate	01	Overall Size	4 x 4-1/2
		Bolt Hole Spacing	2-5/8 x 3-5/8 slotted to 3 x 3
		Attaching Bolt Size	3/8

Options	
CODE	DESCRIPTION
TLB	Top Lock Brake
BR	Bright Brass Plating
CR	Chrome Plating
PBB	Precision Ball Bearing
PSL	4 Position Swivel Lock
SL	Sealed Swivel

Add Option Code to end of part number.



TP6660-01-AFR-PBB-TLB



Pneumatic Caster
TP6680W-01-PNU-PBB-TLB



Pneumatic Caster
TP6610W-01-PNU-PBB-TLB



Air/Flat Free Caster
TP6610W-01-AFR-PBB-TLB

Med / Heavy Kingpinless Casters

TP6600 KPL Series / Capacity up to 1250 Lbs.



Features

- **Finish:** Bright zinc plating
- **Top plate:** 1/4" steel plate
- **Swivel:** One row of 3/8" ball bearings mounted in a heat treated precision machined raceway.
- **Fork Spacing:** 2-1/2"
- **Grease Fittings:** Zerk in swivel section
- **PSL-Notched:** All swivel rigs notched for optional 4-Position
- **Axle:** 1/2" diameter axle with lock nut
- Brakes available on swivel and rigid casters
- **Special Overall Height:** 10-1/8" Available / TP6681-KPL-##

Applications

- Material Handling
- Mobile Storage Racks
- Mobile Tool Chests
- Platform Carts
- Warehouse Trucks

Caster Options

- TLB: Top Lock Brake



- TLB: Top Lock Brake with Rigid



- PSL-Oring

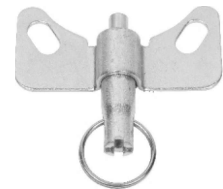

Fastening			
TYPE	CODE	SIZE (Inch)	
Top Plate	KPL-01	Overall Size	4 x 4-1/2
		Bolt Hole Spacing	2-5/8 x 3-5/8 slotted to 3 x 3
		Attaching Bolt Size	3/8
	KPL-07	Overall Size	4-1/2 x 6-1/4
		Bolt Hole Spacing	2-7/16 x 4-15/16 slotted to 3-3/8 x 5-1/4
		Attaching Bolt Size	1/2"

Replace -*- in part number with appropriate fastening code.

Options	
CODE	DESCRIPTION
CLB	Cam Lock Brake
DB	Delrin Bearing
PBB	Precision Bearing
PSL	4 Position Swivel Lock
TLB	Heavy Duty Top Lock Brake

Add Option Code to end of part number.

Wheel Options

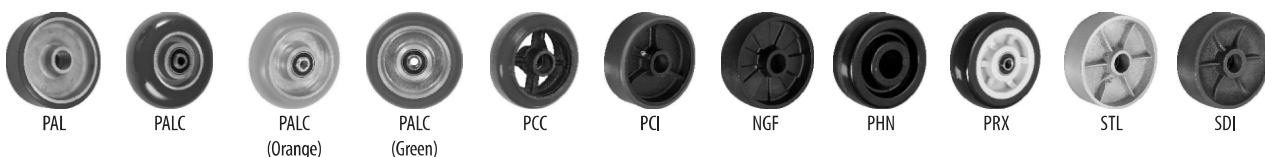

TP6600 KPL Series

Med / Heavy Kingpinless Casters

TP6600 KPL Series / Capacity up to 1250 Lbs.

TP6600 KPL Series

Wheel Diameter	Tread Width	Wheel Type	Swivel Number	Rigid Number	Wheel Bearing	Load Capacity	Overall Height	Swivel Radius
4	2	Fever Hi-Temp	TP6640-KPL-FVR	TP6640R-KPL-FVR	Roller	800	5-5/8	3-9/16
		Heavy Duty Plastic	TP6640-KPL-HDP	TP6640R-KPL-HDP	Plain	550		
		Heavy Duty Plastic	TP6640-KPL-HPR	TP6640R-KPL-HPR	Roller	550		
		Heavy Duty Plastic	TP6640-KPL-HPR-DB	TP6640R-KPL-HPR-DB	Delrin	550		
		Mirage (TPR)	TP6640-KPL-MIR	TP6640R-KPL-MIR	Roller	350		
		Crown Mirage (TPR)	TP6640-KPL-MRC	TP6640R-KPL-MRC	Roller	350		
		Nylon Glass-Filled	TP6640-KPL-NGF	TP6640R-KPL-NGF	Roller	800		
		Polyurethane / Aluminum	TP6640-KPL-PAL	TP6640R-KPL-PAL	Roller	700		
		Polyurethane / Cast Iron	TP6640-KPL-PCI	TP6640R-KPL-PCI	Roller	700		
		Crown Polyurethane / Cast Iron	TP6640-KPL-PCC	TP6640R-KPL-PCC	Roller	700		
		Crown Polyurethane / Cast Iron	TP6640-KPL-PCC-PBB	TP6640R-KPL-PCC-PBB	Precision	600		
		Solid Polyurethane	TP6640-KPL-PLX	TP6640R-KPL-PLX	Roller	600		
		Solid Polyurethane	TP6640-KPL-PLX-DB	TP6640R-KPL-PLX-DB	Delrin	700		
		Solid Polyurethane	TP6640-KPL-PLX-PBB	TP6640R-KPL-PLX-PBB	Precision	700		
		Polyurethane / Nylon	TP6640-KPL-PNY	TP6640R-KPL-PNY	Roller	700		
		Pro-Tech Polyurethane	TP6640-KPL-PRO	TP6640R-KPL-PRO	Roller	700		
		Pro-Tech Polyurethane	TP6640-KPL-PRO-DB	TP6640R-KPL-PRO-DB	Delrin	700		
		Pro-Tech Polyurethane	TP6640-KPL-PRO-PBB	TP6640R-KPL-PRO-PBB	Precision	700		
		Pro-Tech Extra	TP6640-KPL-PRX-PBB	TP6640R-KPL-PRX-PBB	Precision	600		
		Phenolic	TP6640-KPL-PHN	TP6640R-KPL-PHN	Roller	800		
		Phenolic	TP6640-KPL-PHN-DB	TP6640R-KPL-PHN-DB	Delrin	800		
		Phenolic	TP6640-KPL-PHN-PBB	TP6640R-KPL-PHN-PBB	Precision	800		
		Hi-Temp Phenolic	TP6640-KPL-PHN-HT	TP6640R-KPL-PHN-HT	Roller	800		
		Rubber / Aluminum	TP6640-KPL-RAL	TP6640R-KPL-RAL	Roller	250		
Rubber / Cast Iron	TP6640-KPL-RCI	TP6640R-KPL-RCI	Roller	400				
Rubber / Cast Iron	TP6640-KPL-RNY	TP6640R-KPL-RNY	Roller	400				
Steel	TP6640-KPL-STL	TP6640R-KPL-STL	Roller	700				
Ductile Iron	TP6640-KPL-SDI	TP6640R-KPL-SDI	Roller	1000				
V-Groove Steel	TP6640-KPL-VGR	TP6640R-KPL-VGR	Roller	700				
5	2	Fever Hi-Temp	TP6650-KPL-FVR	TP6650R-KPL-FVR	Roller	1000	6-1/2	4-1/4
		Heavy Duty Plastic	TP6650-KPL-HDP	TP6650R-KPL-HDP	Plain	650		
		Heavy Duty Plastic	TP6650-KPL-HPR	TP6650R-KPL-HPR	Roller	650		
		Heavy Duty Plastic	TP6650-KPL-HPR-DB	TP6650R-KPL-HPR-DB	Delrin	650		
		Mirage (TPR)	TP6650-KPL-MIR	TP6650R-KPL-MIR	Roller	400		
		Crown Mirage (TPR)	TP6650-KPL-MRC	TP6650R-KPL-MRC	Roller	400		
		Nylon Glass-Filled	TP6650-KPL-NGF	TP6650R-KPL-NGF	Roller	1000		
		Nylon	TP6650-KPL-NYL	TP6650R-KPL-NYL	Roller	700		
		Nylon	TP6650-KPL-NYL-DB	TP6650R-KPL-NYL-DB	Delrin	700		
		Nylon	TP6650-KPL-NYL-PBB	TP6650R-KPL-NYL-PBB	Precision	700		
		Polyurethane / Aluminum	TP6650-KPL-PAL	TP6650R-KPL-PAL	Roller	1000		
		Polyurethane / Cast Iron	TP6650-KPL-PCI	TP6650R-KPL-PCI	Roller	1000		
		Crown Polyurethane / Cast Iron	TP6650-KPL-PCC	TP6650R-KPL-PCC	Roller	800		
		Crown Polyurethane / Cast Iron	TP6650-KPL-PCC-PBB	TP6650R-KPL-PCC-PBB	Precision	800		
		Solid Polyurethane	TP6650-KPL-PLX	TP6650R-KPL-PLX	Roller	800		
		Solid Polyurethane	TP6650-KPL-PLX-DB	TP6650R-KPL-PLX-DB	Delrin	800		
		Solid Polyurethane	TP6650-KPL-PLX-PBB	TP6650R-KPL-PLX-PBB	Precision	800		
		Polyurethane / Nylon	TP6650-KPL-PNY	TP6650R-KPL-PNY	Roller	1000		
		Pro-Tech Polyurethane	TP6650-KPL-PRO	TP6650R-KPL-PRO	Roller	750		
		Pro-Tech Polyurethane	TP6650-KPL-PRO-DB	TP6650R-KPL-PRO-DB	Delrin	750		
		Pro-Tech Polyurethane	TP6650-KPL-PRO-PBB	TP6650R-KPL-PRO-PBB	Precision	750		
		Pro-Tech Extra	TP6650-KPL-PRX-PBB	TP6650R-KPL-PRX-PBB	Precision	800		
		Phenolic	TP6650-KPL-PHN	TP6650R-KPL-PHN	Roller	1000		
		Phenolic	TP6650-KPL-PHN-DB	TP6650R-KPL-PHN-DB	Delrin	1000		
Phenolic	TP6650-KPL-PHN-PBB	TP6650R-KPL-PHN-PBB	Precision	1000				
Hi-Temp Phenolic	TP6650-KPL-PHN-HT	TP6650R-KPL-PHN-HT	Roller	1000				
Rubber / Aluminum	TP6650-KPL-RAL	TP6650R-KPL-RAL	Roller	500				
Rubber / Cast Iron	TP6650-KPL-RCI	TP6650R-KPL-RCI	Roller	450				
Rubber / Nylon	TP6650-KPL-RNY	TP6650R-KPL-RNY	Roller	450				
Steel	TP6650-KPL-STL	TP6650R-KPL-STL	Roller	1000				
Ductile Iron	TP6650-KPL-SDI	TP6650R-KPL-SDI	Roller	1250				
V-Groove Steel	TP6650-KPL-VGR	TP6650R-KPL-VGR	Roller	900				

Wheel Diameter	Tread Width	Wheel Type	Swivel Number	Rigid Number	Wheel Bearing	Load Capacity	Overall Height	Swivel Radius
6	2	Fever Hi-Temp	TP6660-KPL-FVR	TP6660R-KPL-FVR	Roller	1200	7-1/2	4-1/2
		Heavy Duty Plastic	TP6660-KPL-HDP	TP6660R-KPL-HDP	Plain	700		
		Heavy Duty Plastic	TP6660-KPL-HPR	TP6660R-KPL-HPR	Roller	700		
		Heavy Duty Plastic	TP6660-KPL-HPR-DB	TP6660R-KPL-HPR-DB	Delrin	700		
		Mirage (TPR)	TP6660-KPL-MIR	TP6660R-KPL-MIR	Roller	500		
		Crown Mirage (TPR)	TP6660-KPL-MRC	TP6660R-KPL-MRC	Roller	500		
		Nylon Glass-Filled	TP6660-KPL-NGF	TP6660R-KPL-NGF	Roller	1200		
		Nylon	TP6660-KPL-NYL	TP6660R-KPL-NYL	Roller	800		
		Nylon	TP6660-KPL-NYL-DB	TP6660R-KPL-NYL-DB	Delrin	800		
		Nylon	TP6660-KPL-NYL-PBB	TP6660R-KPL-NYL-PBB	Precision	800		
		Polyurethane / Aluminum	TP6660-KPL-PAL	TP6660R-KPL-PAL	Roller	1200		
		Crown Polyurethane / Aluminum	TP6660-KPL-PALC-PBB	TP6660R-KPL-PALC-PBB	Precision	1200		
		Polyurethane / Cast Iron	TP6660-KPL-PCI	TP6660R-KPL-PCI	Roller	1200		
		Crown Polyurethane / Cast Iron	TP6660-KPL-PCC	TP6660R-KPL-PCC	Roller	900		
		Crown Polyurethane / Cast Iron	TP6660-KPL-PCC-PBB	TP6660R-KPL-PCC-PBB	Precision	900		
		Polyurethane / Cast Iron Solid	TP6660-KPL-PCIS-PBB	TP6660R-KPL-PCIS-PBB	Precision	1250		
		Solid Polyurethane	TP6660-KPL-PLX	TP6660R-KPL-PLX	Roller	900		
		Solid Polyurethane	TP6660-KPL-PLX-DB	TP6660R-KPL-PLX-DB	Delrin	900		
		Solid Polyurethane	TP6660-KPL-PLX-PBB	TP6660R-KPL-PLX-PBB	Precision	900		
		Polyurethane / Nylon	TP6660-KPL-PNY	TP6660R-KPL-PNY	Roller	1200		
		Pro-Tech Polyurethane	TP6660-KPL-PRO	TP6660R-KPL-PRO	Roller	900		
		Pro-Tech Polyurethane	TP6660-KPL-PRO-DB	TP6660R-KPL-PRO-DB	Delrin	900		
		Pro-Tech Polyurethane	TP6660-KPL-PRO-PBB	TP6660R-KPL-PRO-PBB	Precision	900		
		Pro-Tech Extra	TP6660-KPL-PRX-PBB	TP6660R-KPL-PRX-PBB	Precision	1000		
		Phenolic	TP6660-KPL-PHN	TP6660R-KPL-PHN	Roller	1200		
		Phenolic	TP6660-KPL-PHN-DB	TP6660R-KPL-PHN-DB	Delrin	1200		
		Phenolic	TP6660-KPL-PHN-PBB	TP6660R-KPL-PHN-PBB	Precision	1200		
		Hi-Temp Phenolic	TP6660-KPL-PHN-HT	TP6660R-KPL-PHN-HT	Roller	1200		
		Rubber / Aluminum	TP6660-KPL-RAL	TP6660R-KPL-RAL	Roller	500		
		Rubber / Cast Iron	TP6660-KPL-RCI	TP6660R-KPL-RCI	Roller	550		
Rubber / Nylon	TP6660-KPL-RNY	TP6660R-KPL-RNY	Roller	550				
Steel	TP6660-KPL-STL	TP6660R-KPL-STL	Roller	1200				
Ductile Iron	TP6660-KPL-SDI	TP6660R-KPL-SDI	Roller	1250				
V-Groove Steel	TP6660-KPL-VGR	TP6660R-KPL-VGR	Roller	1000				
8	2	Fever Hi-Temp	TP6680-KPL-FVR	TP6680R-KPL-FVR	Roller	1250	9-1/2	6-1/2
		Heavy Duty Plastic	TP6680-KPL-HDP	TP6680R-KPL-HDP	Plain	800		
		Heavy Duty Plastic	TP6680-KPL-HPR	TP6680R-KPL-HPR	Roller	800		
		Heavy Duty Plastic	TP6680-KPL-HPR-DB	TP6680R-KPL-HPR-DB	Delrin	800		
		Mirage (TPR)	TP6680-KPL-MIR	TP6680R-KPL-MIR	Roller	600		
		Crown Mirage (TPR)	TP6680-KPL-MRC	TP6680R-KPL-MRC	Roller	600		
		Nylon Glass-Filled	TP6680-KPL-NGF	TP6680R-KPL-NGF	Roller	1250		
		Nylon	TP6680-KPL-NYL	TP6680R-KPL-NYL	Roller	900		
		Nylon	TP6680-KPL-NYL-DB	TP6680R-KPL-NYL-DB	Delrin	900		
		Nylon	TP6680-KPL-NYL-PBB	TP6680R-KPL-NYL-PBB	Precision	900		
		Polyurethane / Aluminum	TP6680-KPL-PAL	TP6680R-KPL-PAL	Roller	1200		
		Crown Polyurethane / Aluminum	TP6680-KPL-PALC-PBB	TP6680R-KPL-PALC-PBB	Precision	1250		
		Polyurethane / Cast Iron	TP6680-KPL-PCI	TP6680R-KPL-PCI	Roller	1250		
		Crown Polyurethane / Cast Iron	TP6680-KPL-PCC	TP6680R-KPL-PCC	Roller	1000		
		Crown Polyurethane / Cast Iron	TP6680-KPL-PCC-PBB	TP6680R-KPL-PCC-PBB	Precision	1000		
		Polyurethane / Cast Iron Solid	TP6680-KPL-PCIS	TP6680R-KPL-PCIS	Precision	1300		
		Solid Polyurethane	TP6680-KPL-PLX	TP6680R-KPL-PLX	Roller	1000		
		Solid Polyurethane	TP6680-KPL-PLX-DB	TP6680R-KPL-PLX-DB	Delrin	1000		
		Solid Polyurethane	TP6680-KPL-PLX-PBB	TP6680R-KPL-PLX-PBB	Precision	1000		
		Polyurethane / Nylon	TP6680-KPL-PNY	TP6680R-KPL-PNY	Roller	1250		
		Pro-Tech Polyurethane	TP6680-KPL-PRO	TP6680R-KPL-PRO	Roller	950		
		Pro-Tech Polyurethane	TP6680-KPL-PRO-DB	TP6680R-KPL-PRO-DB	Delrin	950		
		Pro-Tech Polyurethane	TP6680-KPL-PRO-PBB	TP6680R-KPL-PRO-PBB	Precision	950		
		Pro-Tech Extra	TP6680-KPL-PRX-PBB	TP6680R-KPL-PRX-PBB	Precision	1200		
		Phenolic	TP6680-KPL-PHN	TP6680R-KPL-PHN	Roller	1250		
		Phenolic	TP6680-KPL-PHN-DB	TP6680R-KPL-PHN-DB	Delrin	1250		
		Phenolic	TP6680-KPL-PHN-PBB	TP6680R-KPL-PHN-PBB	Precision	1250		
		Hi-Temp Phenolic	TP6680-KPL-PHN-HT	TP6680R-KPL-PHN-HT	Roller	1250		
		Rubber / Aluminum	TP6680-KPL-RAL	TP6680R-KPL-RAL	Roller	800		
		Rubber / Cast Iron	TP6680-KPL-RCI	TP6680R-KPL-RCI	Roller	600		
Rubber / Nylon	TP6680-KPL-RNY	TP6680R-KPL-RNY	Roller	600				
Steel	TP6680-KPL-STL	TP6680R-KPL-STL	Roller	1250				
Ductile Iron	TP6680-KPL-SDI	TP6680R-KPL-SDI	Roller	1250				
8	2	Special Overall Height	TP6681-KPL-##	TP6681R-KPL-##			10-1/8"	6-1/4"

Med / Heavy Duty Stainless Steel Casters

TP6700 Series / Capacity up to 1250 Lbs.



Features

- **Top Plate:** 7/32" 304 Stainless steel plate
- **Swivel:** Stainless steel double ball bearing raceway
- **Kingpin:** 5/8" Stainless steel
- **Legs:** 304 Stainless steel plate
- **Grease Fittings:** Zerk in swivel section
- **Axle:** 1/2" diameter stainless steel axle with lock nut

Applications

- Food Service Carts
- Restaurants Equipment
- Washdown Applications
- Wet or Corrosive Conditions

Caster Options

- TLB: Top Lock Brake



- Rigid



TP6700 Series

Fastenings

TYPE	CODE	SIZE (Inch)	
Top Plate	01	Overall Size	4 x 4-1/2
		Bolt Hole Spacing	2-5/8 x 3-5/8 slotted to 3 x 3
		Attaching Bolt Size	3/8

Replace -*- in part number with appropriate fastening code.

Options

CODE	DESCRIPTION
DB	Delrin Bearing
PBB	S/S Precision Bearing
PSL	S/S 4 Position Swivel Lock
SL	Sealed Swivel
TLB	Heavy Duty Top Lock Brake

Add Option Code to end of part number.

Wheel Options



HPR



PHN



PLX



PRO (Red)



PRO (B/G)



PRO (Maroon)

Med / Heavy Duty Stainless Steel Casters

TP6700 Series / Capacity up to 1250 Lbs.

Wheel Diameter	Tread Width	Wheel Type	Swivel Number	Rigid Number	Wheel Bearing	Load Capacity	Overall Height	Swivel Radius
4	2	Heavy Duty Plastic	TP6740-01-HDP	TP6740R-01-HDP	Plain	550	5-5/8	3-9/16
		Mirage (TPR)	TP6740-01-MIR	TP6740R-01-MIR	Roller	350		
		Mirage (TPR)	TP6740-01-MIR-DB	TP6740R-01-MIR-DB	Delrin	350		
		Crown Mirage (TPR)	TP6740-01-MRC	TP6740R-01-MRC	Roller	350		
		Crown Mirage (TPR)	TP6740-01-MRC-DB	TP6740R-01-MRC-DB	Delrin	350		
		Nylon Glass-Filled	TP6740-01-NGF	TP6740R-01-NGF	Roller	800		
		Nylon Glass-Filled	TP6740-01-NGF-DB	TP6740R-01-NGF-DB	Delrin	800		
		Solid Polyurethane	TP6740-01-PLX	TP6740R-01-PLX	Roller	700		
		Solid Polyurethane	TP6740-01-PLX-DB	TP6740R-01-PLX-DB	Delrin	700		
		Pro-Tech Polyurethane	TP6740-01-PRO	TP6740R-01-PRO	Roller	700		
		Pro-Tech Polyurethane	TP6740-01-PRO-DB	TP6740R-01-PRO-DB	Delrin	700		
		Phenolic	TP6740-01-PHN	TP6740R-01-PHN	Roller	800		
		Phenolic	TP6740-01-PHN-DB	TP6740R-01-PHN-DB	Delrin	800		
5	2	Heavy Duty Plastic	TP6750-01-HDP	TP6750R-01-HDP	Plain	650	6-1/2	4-1/4
		Mirage (TPR)	TP6750-01-MIR	TP6750R-01-MIR	Roller	400		
		Mirage (TPR)	TP6750-01-MIR-DB	TP6750R-01-MIR-DB	Delrin	400		
		Crown Mirage (TPR)	TP6750-01-MRC	TP6750R-01-MRC	Roller	400		
		Crown Mirage (TPR)	TP6750-01-MRC-DB	TP6750R-01-MRC-DB	Delrin	400		
		Nylon Glass-Filled	TP6750-01-NGF	TP6750R-01-NGF	Roller	1000		
		Nylon Glass-Filled	TP6750-01-NGF-DB	TP6750R-01-NGF-DB	Delrin	1000		
		Nylon	TP6750-01-NYL	TP6750R-01-NYL	Roller	700		
		Nylon	TP6750-01-NYL-DB	TP6750R-01-NYL-DB	Delrin	700		
		Solid Polyurethane	TP6750-01-PLX	TP6750R-01-PLX	Roller	800		
		Solid Polyurethane	TP6750-01-PLX-DB	TP6750R-01-PLX-DB	Delrin	800		
		Pro-Tech Polyurethane	TP6750-01-PRO	TP6750R-01-PRO	Roller	750		
		Pro-Tech Polyurethane	TP6750-01-PRO-DB	TP6750R-01-PRO-DB	Delrin	750		
Phenolic	TP6750-01-PHN	TP6750R-01-PHN	Roller	1000				
Phenolic	TP6750-01-PHN-DB	TP6750R-01-PHN-DB	Delrin	1000				
6	2	Heavy Duty Plastic	TP6760-01-HDP	TP6760R-01-HDP	Plain	700	7-1/2	4-1/2
		Mirage (TPR)	TP6760-01-MIR	TP6760R-01-MIR	Roller	500		
		Mirage (TPR)	TP6760-01-MIR-DB	TP6760R-01-MIR-DB	Delrin	500		
		Crown Mirage (TPR)	TP6760-01-MRC	TP6760R-01-MRC	Roller	500		
		Crown Mirage (TPR)	TP6760-01-MRC-DB	TP6760R-01-MRC-DB	Delrin	500		
		Nylon Glass-Filled	TP6760-01-NGF	TP6760R-01-NGF	Roller	1200		
		Nylon Glass-Filled	TP6760-01-NGF-DB	TP6760R-01-NGF-DB	Delrin	1200		
		Nylon	TP6760-01-NYL	TP6760R-01-NYL	Roller	800		
		Nylon	TP6760-01-NYL-DB	TP6760R-01-NYL-DB	Delrin	800		
		Solid Polyurethane	TP6760-01-PLX	TP6760R-01-PLX	Roller	900		
		Solid Polyurethane	TP6760-01-PLX-DB	TP6760R-01-PLX-DB	Delrin	900		
		Pro-Tech Polyurethane	TP6760-01-PRO	TP6760R-01-PRO	Roller	900		
		Pro-Tech Polyurethane	TP6760-01-PRO-DB	TP6760R-01-PRO-DB	Delrin	900		
Phenolic	TP6760-01-PHN	TP6760R-01-PHN	Roller	1200				
Phenolic	TP6760-01-PHN-DB	TP6760R-01-PHN-DB	Delrin	1200				
8	2	Heavy Duty Plastic	TP6780-01-HDP	TP6780R-01-HDP	Plain	800	9-1/2	6-1/2
		Mirage (TPR)	TP6780-01-MIR	TP6780R-01-MIR	Roller	600		
		Mirage (TPR)	TP6780-01-MIR-DB	TP6780R-01-MIR-DB	Delrin	600		
		Crown Mirage (TPR)	TP6780-01-MRC	TP6780R-01-MRC	Roller	600		
		Crown Mirage (TPR)	TP6780-01-MRC-DB	TP6780R-01-MRC-DB	Delrin	600		
		Nylon Glass-Filled	TP6780-01-NGF	TP6780R-01-NGF	Roller	1250		
		Nylon Glass-Filled	TP6780-01-NGF-DB	TP6780R-01-NGF-DB	Delrin	1250		
		Nylon	TP6780-01-NYL	TP6780R-01-NYL	Roller	900		
		Nylon	TP6780-01-NYL-DB	TP6780R-01-NYL-DB	Delrin	900		
		Solid Polyurethane	TP6780-01-PLX	TP6780R-01-PLX	Roller	1000		
		Solid Polyurethane	TP6780-01-PLX-DB	TP6780R-01-PLX-DB	Delrin	1000		
		Pro-Tech Polyurethane	TP6780-01-PRO	TP6780R-01-PRO	Roller	950		
		Pro-Tech Polyurethane	TP6780-01-PRO-DB	TP6780R-01-PRO-DB	Delrin	950		
Phenolic	TP6780-01-PHN	TP6780R-01-PHN	Roller	1250				
Phenolic	TP6780-01-PHN-DB	TP6780R-01-PHN-DB	Delrin	1250				

TP6700 SA Series

Medium-Heavy Duty Casters

TP6800 Series / Capacity up to 1400 Lbs.



Features

- **Finish:** Bright zinc plating
- **Swivel:** Double ball bearing with hardened raceways for extra strength
- **Rigid:** Welded with heavy duty gauge steel for extra strength
- **Fork Leg Spacing:** 2-1/2"
- **Top plate & Legs:** 1/4" thick top plate and legs for additional strength
- **Construction:** Large top plate and raceway combine ease of swiveling and strength
- **Grease Fittings:** Provided in swivel raceway and wheel bearings
- **PSL-Notched:** All swivel rigs notched for optional 4-Position swivel lock
- **Axle:** 1/2" diameter axle with lock nut

Applications

- Cargo Containers
- Freight Terminal Trucks
- Material Handling Cart
- Large Platform Trucks

Caster Options

- TLB: Top Lock Brake



- Rigid



TP6800 Series

Fastening

TYPE	CODE	SIZE (Inch)	
Top Plate	01	Overall Size	4-1/2 x 6-1/4
		Bolt Hole Spacing	2-7/16 x 4-15/16 slotted to 3-3/8 x 5-1/4
		Attaching Bolt Size	1/2"

Replace -*- in part number with appropriate fastening code.

Options

CODE	DESCRIPTION
DB	Delrin Bearing
BB	Ball Bearing
PBB	Precision Ball Bearing
PSL	4 Position Swivel Lock
TG	Thread Guard
TLB	Heavy Duty Top Lock Brack

Add Option Code to end of part number.

Caster Selection Guide



TP6850-01-PHN

Wheel Options

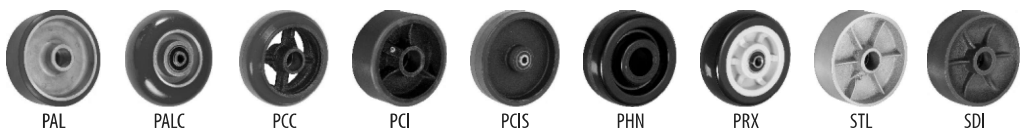

Medium-Heavy Duty Casters

TP6800 Series / Capacity up to 1400 Lbs.

Wheel Diameter	Tread Width	Wheel Type	Swivel Number	Rigid Number	Wheel Bearing	Load Capacity	Overall Height	Swivel Radius
4	2	Heavy Duty Plastic	TP6840-01-HPR	TP6840R-01-HPR	Roller	550	5-5/8	3-13/16
		Mirage (TPR)	TP6840-01-MIR	TP6840R-01-MIR	Roller	350		
		Crown Mirage (TPR)	TP6840-01-MRC	TP6840R-01-MRC	Roller	350		
		Nylon Glass-Filled	TP6840-01-NGF	TP6840R-01-NGF	Roller	800		
		Polyurethane / Aluminum	TP6840-01-PAL	TP6840R-01-PAL	Roller	700		
		Polyurethane / Cast Iron	TP6840-01-PCI	TP6840R-01-PCI	Roller	700		
		Phenolic	TP6840-01-PHN	TP6840R-01-PHN	Roller	800		
		Solid Polyurethane	TP6840-01-PLX	TP6840R-01-PLX	Roller	700		
		Polyurethane / Nylon	TP6840-01-PNY	TP6840R-01-PNY	Roller	700		
		Pro-Tech Polyurethane	TP6840-01-PRO	TP6840R-01-PRO	Roller	700		
		Pro-Tech Xtra	TP6840-01-PRX-PBB	TP6840R-01-PRX-PBB	Precision	700		
		Rubber / Cast Iron	TP6840-01-RCI	TP6840R-01-RCI	Roller	400		
		Steel	TP6840-01-STL	TP6840R-01-STL	Roller	700		
Ductile Iron	TP6840-01-SDI	TP6840R-01-SDI	Roller	1000				
5	2	Heavy Duty Plastic	TP6850-01-HPR	TP6850R-01-HPR	Roller	650	6-1/2	4
		Mirage (TPR)	TP6850-01-MIR	TP6850R-01-MIR	Roller	400		
		Crown Mirage (TPR)	TP6850-01-MRC	TP6850R-01-MRC	Roller	400		
		Nylon Glass-Filled	TP6850-01-NGF	TP6850R-01-NGF	Roller	1000		
		Polyurethane / Aluminum	TP6850-01-PAL	TP6850R-01-PAL	Roller	1000		
		Polyurethane / Cast Iron	TP6850-01-PCI	TP6850R-01-PCI	Roller	1000		
		Phenolic	TP6850-01-PHN	TP6850R-01-PHN	Roller	1000		
		Solid Polyurethane	TP6850-01-PLX	TP6850R-01-PLX	Roller	800		
		Polyurethane / Nylon	TP6850-01-PNY	TP6850R-01-PNY	Roller	1000		
		Pro-Tech Polyurethane	TP6850-01-PRO	TP6850R-01-PRO	Roller	750		
		Pro-Tech Xtra	TP6850-01-PRX-PBB	TP6850R-01-PRX-PBB	Precision	800		
		Rubber / Cast Iron	TP6850-01-RCI	TP6850R-01-RCI	Roller	450		
		Steel	TP6850-01-STL	TP6850R-01-STL	Roller	1000		
Ductile Iron	TP6850-01-SDI	TP6850-01-SDI	Roller	1250				
6	2	Heavy Duty Plastic	TP6860-01-HPR	TP6860R-01-HPR	Roller	700	7-1/2	4-3/4
		Mirage (TPR)	TP6860-01-MIR	TP6860R-01-MIR	Roller	500		
		Crown Mirage (TPR)	TP6860-01-MRC	TP6860R-01-MRC	Roller	500		
		Nylon Glass-Filled	TP6860-01-NGF	TP6860R-01-NGF	Roller	1200		
		Polyurethane / Aluminum	TP6660-01-PAL	TP6660R-01-PAL	Roller	1200		
		Crown Polyurethane / AL.	TP6860-01-PALC-PBB	TP6860R-01-PALC-PBB	Precision	1200		
		Polyurethane / Cast Iron	TP6860-01-PCI	TP6860R-01-PCI	Roller	1200		
		Polyurethane / Cast Iron Solid	TP6860-01-PCIS-PBB	TP6860R-01-PCIS-PBB	Precision	1250		
		Phenolic	TP6860-01-PHN	TP6860R-01-PHN	Roller	1200		
		Solid Polyurethane	TP6860-01-PLX	TP6860R-01-PLX	Roller	900		
		Polyurethane / Nylon	TP6860-01-PNY	TP6860R-01-PNY	Roller	1200		
		Pro-Tech Polyurethane	TP6860-01-PRO	TP6860R-01-PRO	Roller	900		
		Pro-Tech Xtra	TP6860-01-PRX-PBB	TP6860R-01-PRX-PBB	Precision	1000		
Rubber / Cast Iron	TP6860-01-RCI	TP6860R-01-RCI	Roller	550				
Steel	TP6860-01-STL	TP6860R-01-STL	Roller	1200				
Ductile Iron	TP6860-01-SDI	TP6860R-01-SDI	Roller	1250				
8	2	Heavy Duty Plastic	TP6880-01-HPR	TP6880R-01-HPR	Roller	700	9-3/4	6-1/4
		Mirage (TPR)	TP6880-01-MIR	TP6880R-01-MIR	Roller	500		
		Crown Mirage (TPR)	TP6880-01-MRC	TP6880R-01-MRC	Roller	500		
		Nylon Glass-Filled	TP6880-01-NGF	TP6880R-01-NGF	Roller	1250		
		Polyurethane / Aluminum	TP6680-01-PAL	TP6680R-01-PAL	Roller	1200		
		Crown Polyurethane / AL.	TP6880-01-PALC-PBB	TP6880R-01-PALC-PBB	Precision	1250		
		Polyurethane / Cast Iron	TP6880-01-PCI	TP6880R-01-PCI	Roller	1200		
		Polyurethane / Cast Iron Solid	TP6880-01-PCIS-PBB	TP6880R-01-PCIS-PBB	Precision	1300		
		Phenolic	TP6880-01-PHN	TP6880R-01-PHN	Roller	1250		
		Solid Polyurethane	TP6880-01-PLX	TP6880R-01-PLX	Roller	1000		
		Polyurethane / Nylon	TP6880-01-PNY	TP6880R-01-PNY	Roller	1250		
		Pro-Tech Polyurethane	TP6880-01-PRO	TP6880R-01-PRO	Roller	950		
		Pro-Tech Xtra	TP6880-01-PRX-PBB	TP6880R-01-PRX-PBB	Precision	1200		
Rubber / Cast Iron	TP6880-01-RCI	TP6880R-01-RCI	Roller	600				
Steel	TP6880-01-STL	TP6880R-01-STL	Roller	1250				
Ductile Iron	TP6880-01-SDI	TP6880R-01-SDI	Roller	1400				

TP6800 Series

Heavy Duty Casters

TP6900 Series / Capacity up to 2000 Lbs.



Features

- **Finish:** Bright zinc plating
- **Swivel:** Double ball bearing with hardened raceways for extra strength
- **Rigid:** Welded with heavy duty gauge steel for extra strength
- **Fork Spacing:** 3"
- **Construction:** Large top plate and raceway combine ease of swiveling and strength
- **Kingpin:** 3/4" diameter bolt and nut
- **Grease Fittings:** Zerk in swivel section
- **Legs:** - HD - 23/64" Thickness
- 01 - 15/64" Thickness
- **Axle:** - HD - 3/4" diameter axle with lock nut
- 01 - 1/2" diameter axle with lock nut

Applications

- Cargo Containers
- Freight Terminal Trucks
- Material Handling Carts
- Large Platform Trucks

Caster Options

Wheel Diameter	Tread Width	Wheel Type	Swivel Number	Rigid Number	Wheel Bearing	Load Capacity	Overall Height	Swivel Radius
6	2-1/2	Polyurethane / Cast Iron	TP6960-HD-PCI	TP6960R-HD-PCI	Roller	1500	7-1/2	4-3/4
		Phenolic	TP6960-HD-PHN	TP6960R-HD-PHN	Roller	1500		
		Rubber / Cast Iron	TP6960-HD-RCI	TP6960R-HD-RCI	Roller	700		
		Steel	TP6960-HD-STL	TP6960R-HD-STL	Roller	1500		
		Ductile Iron	TP6960-HD-SDI	TP6960R-HD-SDI	Roller	1800		
8	2-1/2	Polyurethane / Cast Iron	TP6980-HD-PCI	TP6980R-HD-PCI	Roller	1600	9-3/4	6-1/4
		Phenolic	TP6980-HD-PHN	TP6980R-HD-PHN	Roller	1600		
		Rubber / Cast Iron	TP6980-HD-RCI	TP6980R-HD-RCI	Roller	850		
		Steel	TP6980-HD-STL	TP6980R-HD-STL	Roller	1600		
		Ductile Iron	TP6980-HD-SDI	TP6980R-HD-SDI	Roller	2000		
10	2-1/2	Polyurethane / Cast Iron	TP6910-HD-PCI	TP6910R-HD-PCI	Roller	1800	11-1/2	7-3/8
		Phenolic	TP6910-HD-PHN	TP6910R-HD-PHN	Roller	1800		
		Rubber / Cast Iron	TP6910-HD-RCI	TP6910R-HD-RCI	Roller	950		
		Steel	TP6910-HD-STL	TP6910R-HD-STL	Roller	1800		
		Ductile Iron	TP6910-HD-SDI	TP6910R-HD-SDI	Roller	2000		

TP6900 Series

Fastening			
TYPE	CODE	SIZE (Inch)	
Top Plate	HD	Overall Size	4-1/2 x 6-1/4
		Bolt Hole Spacing	2-7/16 x 4-15/16 slotted to 3-3/8 x 5-1/4
		Attaching Bolt Size	1/2"

Options	
CODE	DESCRIPTION
WB	Wheel Brake

Add Option Code to end of part number.

Replace -*- in part number with appropriate fastening code.

Heavy Duty Drop Forged Casters

TP7000 Series / Capacity up to 1500 Lbs.



Features

- **Finish:** Bright zinc plating
- **Top Plate:** 3/8" AISI 1045 drop forged steel for maximum strength
- **Swivel:** Double ball bearing coined "deep-groove" load and machined component trust raceway
- **Rigid:** Welded with heavy duty gauge street for extra strength
- **Fork Spacing:** 2-1/2"
- **Legs:** 15/64" steel, machine welded, engineered and formed to resist bending.
- **Kingpin:** 3/4" diameter bolt and nut
- **Grease Fittings:** Zerk in swivel section
- **Axle:** 1/2" diameter axle with lock nut

Applications

- Cargo Containers
- Freight Terminal Trucks
- Material Handling Carts
- Large Platform Trucks

Wheel Diameter	Tread Width	Wheel Type	Swivel Number	Rigid Number	Wheel Bearing	Load Capacity	Overall Height	Swivel Radius
4	2	Nylon Glass-Filled	TP7040-01-NGF	TP7040R-01-NGF	Roller	800	5-5/8	3-13/16
		Polyurethane / Cast Iron	TP7040-01-PCI	TP7040R-01-PCI	Roller	800		
		Phenolic	TP7040-01-PHN	TP7040R-01-PHN	Roller	800		
		Solid Polyurethane	TP7040-01-PLX	TP7040R-01-PLX	Roller	700		
		Pro-Tech Extra	TP7040-01-PRX-PBB	TP7040R-01-PRX-PBB	Precision	600		
		Steel	TP7040-01-STL	TP7040R-01-STL	Roller	700		
		Ductile Iron	TP7040-01-SDI	TP7040R-01-SDI	Roller	1000		
5	2	Nylon Glass-Filled	TP7050-01-NGF	TP7050R-01-NGF	Roller	1000	6-1/2	4
		Polyurethane / Cast Iron	TP7050-01-PCI	TP7050R-01-PCI	Roller	1000		
		Phenolic	TP7050-01-PHN	TP7050R-01-PHN	Roller	1000		
		Solid Polyurethane	TP7050-01-PLX	TP7050R-01-PLX	Roller	800		
		Pro-Tech Extra	TP7050-01-PRX-PBB	TP7050R-01-PRX-PBB	Precision	800		
		Steel	TP7050-01-STL	TP7050R-01-STL	Roller	1000		
		Ductile Iron	TP7050-01-SDI	TP7050R-01-SDI	Roller	1500		
6	2	Nylon Glass-Filled	TP7060-01-NGF	TP7060R-01-NGF	Roller	1200	7-1/2	4-3/4
		Polyurethane / Aluminum	TP7060-01-PAL	TP7060R-01-PAL	Roller	1000		
		Crown Polyurethane / AL.	TP7060-01-PALC	TP7060R-01-PALC	Precision	1000		
		Polyurethane / Cast Iron	TP7060-01-PCI	TP7060R-01-PCI	Roller	1200		
		Polyurethane / Cast Iron	TP7060-01-PCIS-PBB	TP7060R-01-PCIS-PBB	Precision	1250		
		Phenolic	TP7060-01-PHN	TP7060R-01-PHN	Roller	1200		
		Plex Solid Polyurethane	TP7060-01-PLX	TP7060R-01-PLX	Roller	900		
		Pro-Tech Extra	TP7060-01-PRX-PBB	TP7060R-01-PRX-PBB	Precision	1000		
		Steel	TP7060-01-STL	TP7060R-01-STL	Roller	1200		
		Ductile Iron	TP7060-01-SDI	TP7060R-01-SDI	Roller	1500		
8	2	Nylon Glass-Filled	TP7080-01-NGF	TP7080R-01-NGF	Roller	1400	10-1/8	6-1/4
		Polyurethane / Aluminum	TP7080-01-PAL	TP7080R-01-PAL	Roller	1200		
		Crown Polyurethane / AL.	TP7080-01-PALC	TP7080R-01-PALC	Precision	1200		
		Polyurethane / Cast Iron	TP7080-01-PCI	TP7080R-01-PCI	Roller	1400		
		Polyurethane / Cast Iron	TP7080-01-PCIS-PBB	TP7080R-01-PCIS-PBB	Precision	1300		
		Phenolic	TP7080-01-PHN	TP7080R-01-PHN	Roller	1400		
		Solid Polyurethane	TP7080-01-PLX	TP7080R-01-PLX	Roller	1200		
		Pro-Tech Extra	TP7080-01-PRX-PBB	TP7080R-01-PRX-PBB	Precision	1200		
		Steel	TP7080-01-STL	TP7080R-01-STL	Roller	1400		
		Ductile Iron	TP7080-01-SDL	TP7080R-01-SDI	Roller	1500		

Fastening

TYPE	CODE	SIZE (Inch)	
Top Plate	01	Overall Size	4-1/2 x 6-1/4
		Bolt Hole Spacing	2-7/16 x 4-15/16 slotted to 3-3/8 x 5-1/4
		Attaching Bolt Size	1/2"

Options

CODE	DESCRIPTION
WB	Wheel Brake
DW	Double Welded Legs

Add Option Code to end of part number.

Replace -*-* in part number with appropriate fastening code.

Heavy Duty Drop Forged Casters

TP7100 Series / Capacity up to 4000 Lbs.



Features

- **Finish:** Bright zinc plating
- **Top Plate:** 3/8" AISI 1045 drop forged steel for maximum strength
- **Swivel:** Double ball bearing coined "deep-groove" load and machined component trust raceway
- **Rigid:** Welded with heavy duty gauge steel for extra strength
- **Fork Spacing:** 3"
- **Legs:** 23/64" steel, machine welded, engineered and formed to resist bending.
- **Kingpin:** 3/4" diameter bolt and nut
- **Grease Fittings:** Zerk in swivel section
- **Axle:** 3/4" diameter axle with lock nut

Applications

- Cargo Containers
- Freight Terminal Trucks
- Textile Carts & Storage Racks
- Trash Containers
- Heavy Duty Platform Trucks

Caster Options

- **WB:** Wheel Brake



- **PSL:** 4-Position Swivel Lock



Wheel Diameter	Tread Width	Wheel Type	Swivel Number	Rigid Number	Wheel Bearing	Load Capacity	Overall Height	Swivel Radius
4	2-3/4	Polyurethane / Cast Iron	TP7140-01-PCI	TP7140R-01-PCI	Roller	1500	5-5/8	3-7/16
6	2-1/2	Polyurethane / Cast Iron	TP7160-01-PCI	TP7160R-01-PCI	Roller	1600	7-1/2	5-1/4
		Phenolic	TP7160-01-PHN	TP7160R-01-PHN	Roller	1600		
		Rubber / Cast Iron	TP7160-01-RCI	TP7160R-01-RCI	Roller	700		
		Steel	TP7160-01-STL	TP7160R-01-STL	Roller	1600		
		Ductile Iron	TP7160-01-SDI	TP7160R-01-SDI	Roller	340		
8	2-1/2	Polyurethane / Cast Iron	TP7180-01-PCI	TP7180R-01-PCI	Roller	2000	10-1/8	6-1/4
		Phenolic	TP7180-01-PHN	TP7180R-01-PHN	Roller	2000		
		Rubber / Cast Iron	TP7180-01-RCI	TP7180R-01-RCI	Roller	850		
		Steel	TP7180-01-STL	TP7180R-01-STL	Roller	1800		
		Ductile Iron	TP7180-01-SDI	TP7180R-01-SDI	Roller	4000		
10	2-1/2	Polyurethane / Cast Iron	TP7110-01-PCI	TP7110R-01-PCI	Roller	2200	11-7/8	7-9/16
		Phenolic	TP7110-01-PHN	TP7110R-01-PHN	Roller	2500		
		Rubber / Cast Iron	TP7110-01-RCI	TP7110R-01-RCI	Roller	950		
		Steel	TP7110-01-STL	TP7110R-01-STL	Roller	2000		
		Ductile Iron	TP7110-01-SDI	TP7110R-01-SDI	Roller	4000		
12	2-1/2	Polyurethane / Cast Iron	TP7112-01-PCI	TP7112R-01-PCI	Roller	2500	13-7/8	8-9/16
		Phenolic	TP7112-01-PHN	TP7112R-01-PHN	Roller	3000		
		Rubber / Cast Iron	TP7112-01-RCI	TP7112R-01-RCI	Roller	1000		
		Steel	TP7112-01-STL	TP7112R-01-STL	Roller	2200		
		Ductile Iron	TP7112-01-SDI	TP7112R-01-SDI	Roller	4000		

Fastening

TYPE	CODE	SIZE (Inch)	
Top Plate	01	Overall Size	4-1/2 x 6-1/4
		Bolt Hole Spacing	2-7/16 x 4-15/16 slotted to 3-3/8 x 5-1/4
		Attaching Bolt Size	1/2"

Replace -*- in part number with appropriate fastening code.

Options

CODE	DESCRIPTION
WB	Wheel Brake
PSL	4 Position Swivel Lock

Add Option Code to end of part number.

TP7100 Series

Heavy Duty Drop Forged Casters

TP7200 Series / Capacity up to 4000 Lbs.



Features

- **Finish:** Bright zinc plating
- **Top Plate:** 13/32" AISI 1045 drop forged steel for maximum strength
- **Swivel:** Double ball bearing coined "deep-groove" load and machined component trust raceway
- **Rigid:** Welded with heavy duty gauge steel for extra strength
- **Fork Spacing:** 3"
- **Legs:** 3/8" steel, machine welded, engineered and formed to resist bending.
- **Kingpin:** 3/4" diameter bolt and nut
- **Grease Fittings:** Zerk in swivel section
- **Axle:** 3/4" diameter axle with lock nut

Applications

- Cargo Containers
- Freight Terminal Trucks
- Textile Carts & Storage Racks
- Trash Containers
- Heavy Duty Platform Trucks

Caster Options

- WB: Wheel Brake
- PSL: 4-Position Swivel Lock



Wheel Diameter	Tread Width	Wheel Type	Swivel Number	Rigid Number	Wheel Bearing	Load Capacity	Overall Height	Swivel Radius
6	2-1/2	Polyurethane / Cast Iron	TP7260-01-PCI	TP7260R-01-PCI	Roller	1600	7-5/8	5-3/16
		Phenolic	TP7260-01-PHN	TP7260R-01-PHN	Roller	1600		
		Rubber / Cast Iron	TP7260-01-RCI	TP7260R-01-RCI	Roller	700		
		Steel	TP7260-01-STL	TP7260R-01-STL	Roller	1600		
		Ductile Iron	TP7260-01-SDI	TP7260R-01-SDI	Roller	3400		
8	2-1/2	Polyurethane / Cast Iron	TP7280-01-PCI	TP7280R-01-PCI	Roller	2000	10-1/8	6-3/16
		Phenolic	TP7280-01-PHN	TP7280R-01-PHN	Roller	2000		
		Rubber / Cast Iron	TP7280-01-RCI	TP7280R-01-RCI	Roller	850		
		Steel	TP7280-01-STL	TP7280R-01-STL	Roller	1800		
		Ductile Iron	TP7280-01-SDI	TP7280R-01-SDI	Roller	4000		
10	2-1/2	Polyurethane / Cast Iron	TP7210-01-PCI	TP7210R-01-PCI	Roller	2200	11-1/2	7-9/16
		Phenolic	TP7210-01-PHN	TP7210R-01-PHN	Roller	2500		
		Rubber / Cast Iron	TP7210-01-RCI	TP7210R-01-RCI	Roller	950		
		Steel	TP7210-01-STL	TP7210R-01-STL	Roller	2000		
		Ductile Iron	TP7210-01-SDI	TP7210R-01-SDI	Roller	4000		
12	2-1/2	Polyurethane / Cast Iron	TP7212-01-PCI	TP7212R-01-PCI	Roller	2500	13-1/2	8-9/16
		Phenolic	TP7212-01-PHN	TP7212R-01-PHN	Roller	3000		
		Rubber / Cast Iron	TP7212-01-RCI	TP7212R-01-RCI	Roller	1000		
		Steel	TP7212-01-STL	TP7212R-01-STL	Roller	2200		
		Ductile Iron	TP7212-01-SDI	TP7212R-01-SDI	Roller	4000		

Fastening			
TYPE	CODE	SIZE (Inch)	
Top Plate	01	Overall Size	5-1/4 x 7-1/4
		Bolt Hole Spacing	3-3/8 x 5-1/4 slotted to 4-1/8 x 6-1/8
		Attaching Bolt Size	1/2"

Options	
CODE	DESCRIPTION
WB	Wheel Brake
PSL	4 Position Swivel Lock

Add Option Code to end of part number.

Replace -*- in part number with appropriate fastening code.

TP7200 Series

Heavy Duty Kingpinless Casters

TP7200 KPL Series / Capacity up to 5400 Lbs.



Features

- **Finish:** Bright zinc plating
- **Top Plate:** 5/16" Steel plate
- **Swivel:** One row of 1/2" ball bearing mounted in a heat treated precision machined raceway
- **Fork Spacing:** 3-1/2"
- **Leg Thickness:** 5/16" steel plate
- **Grease Fittings:** Zerk in swivel section
- **PSL-Notched:** All swivel rigs notched for optional 4-Position
- **Axle:** 3/4" diameter axle with lock nut

Applications

- Military Equipment
- Air Cargo & Ground Support
- Tow Line & Shock Load Applications
- Platform Trucks & Freight Terminal Dollies

Caster Options

- WB: Wheel Brake



- PSL: 4-Position Swivel Lock



Wheel Diameter	Tread Width	Wheel Type	Swivel Number	Rigid Number	Wheel Bearing	Load Capacity	Overall Height	Swivel Radius	Swivel Lead
6	3	Polyurethane / Cast Iron	TP7260-KPL-**-PCI	TP7260R-KPL-**-PCI	Roller	2000	7-1/2	4-3/8	1-3/8
		Phenolic	TP7260-KPL-**-PHN	TP7260R-KPL-**-PHN	Roller	2000			
		Rubber / Cast Iron	TP7260-KPL-**-RCI	TP7260R-KPL-**-RCI	Roller	750			
		Steel	TP7260-KPL-**-STL	TP7260R-KPL-**-STL	Roller	2500			
		Ductile Iron	TP7260-KPL-**-SDI	TP7260R-KPL-**-SDI	Roller	4800			
8	3	Polyurethane / Cast Iron	TP7280-KPL-**-PCI	TP7280R-KPL-**-PCI	Roller	2500	10-1/8	6-1/16	2-1/16
		Phenolic	TP7280-KPL-**-PHN	TP7280R-KPL-**-PHN	Roller	2500			
		Rubber / Cast Iron	TP7280-KPL-**-RCI	TP7280R-KPL-**-RCI	Roller	900			
		Steel	TP7280-KPL-**-STL	TP7280R-KPL-**-STL	Roller	2500			
		Ductile Iron	TP7280-KPL-**-SDI	TP7280R-KPL-**-SDI	Roller	5400			
10	3	Polyurethane / Cast Iron	TP7210-KPL-**-PCI	TP7210R-KPL-**-PCI	Roller	3000	11-1/2	7-1/4	2-1/4
		Phenolic	TP7210-KPL-**-PHN	TP7210R-KPL-**-PHN	Roller	2900			
		Rubber / Cast Iron	TP7210-KPL-**-RCI	TP7210R-KPL-**-RCI	Roller	1000			
		Steel	TP7210-KPL-**-STL	TP7210R-KPL-**-STL	Roller	2500			
		Ductile Iron	TP7210-KPL-**-SDI	TP7210R-KPL-**-SDI	Roller	5400			
12	3	Polyurethane / Cast Iron	TP7212-KPL-**-PCI	TP7212R-KPL-**-PCI	Roller	3200	13-1/2	8-11/16	2-11/16
		Phenolic	TP7212-KPL-**-PHN	TP7212R-KPL-**-PHN	Roller	3500			
		Rubber / Cast Iron	TP7212-KPL-**-RCI	TP7212R-KPL-**-RCI	Roller	1200			
		Steel	TP7212-KPL-**-STL	TP7212R-KPL-**-STL	Roller	2500			
		Ductile Iron	TP7212-KPL-**-SDI	TP7212R-KPL-**-SDI	Roller	5400			

Fastening

TYPE	CODE	SIZE (Inch)	
Top Plate	KPL-01	Overall Size	4-1/4 x 6-1/4 x 5/16
		Bolt Hole Spacing	2-7/16 x 4-15/16 slotted to 3-3/8 x 5-1/4
		Attaching Bolt Size	1/2"
	KPL-02	Overall Size	5-1/4 x 7-1/4 x 5/16
		Bolt Hole Spacing	3-3/8 x 5-1/4 slotted to 4-1/8 x 6-1/8
		Attaching Bolt Size	1/2"

Options

CODE	DESCRIPTION
WB	Wheel Brake
PSL	4 Position Swivel Lock

Add Option Code to end of part number

Replace -*- in part number with appropriate fastening code.

TP7200 KPL Series

Heavy Duty Kingpinless Casters

TP7500 KPL Series / Capacity up to 5400 Lbs.



Features

- **Finish:** Bright zinc plating
- **Top Plate:** 3/8" Steel plate
- **Swivel:** One row of 1/2" ball bearing mounted in a heat treated precision machined raceway
- **Fork Spacing:** 3-1/2"
- **Leg Thickness:** 3/8" steel plate
- **Grease Fittings:** Zerk in swivel section
- **PSL-Notched:** All swivel rigs notched for optional 4-Position
- **Axle:** 3/4" diameter axle with lock nut

Applications

- Military Equipment
- Air Cargo & Ground Support
- Tow Line & Shock Load Applications
- Platform Trucks & Freight Terminal Dollies

Caster Options

- **WB:** Wheel Brake



- **PSL:** 4-Position Swivel Lock



Wheel Diameter	Tread Width	Wheel Type	Swivel Number	Rigid Number	Wheel Bearing	Load Capacity	Overall Height	Swivel Radius	Swivel Lead
6	3	Polyurethane / Cast Iron	TP7560-KPL-**-PCI	TP7560R-KPL-**-PCI	Roller	2000	8	5-7/32	2-7/32
		Phenolic	TP7560-KPL-**-PHN	TP7560R-KPL-**-PHN	Roller	2000			
		Rubber / Cast Iron	TP7560-KPL-**-RCI	TP7560R-KPL-**-RCI	Roller	750			
		Steel	TP7560-KPL-STL	TP7560R-KPL-**-STL	Roller	2500			
		Ductile Iron	TP7560-KPL-**-SDI	TP7560R-KPL-**-SDI	Roller	4800			
8	3	Polyurethane / Cast Iron	TP7580-KPL-**-PCI	TP7580R-KPL-**-PCI	Roller	2500	10-1/2	6-15/16	2-15/16
		Phenolic	TP7580-KPL-**-PHN	TP7580R-KPL-**-PHN	Roller	2500			
		Rubber / Cast Iron	TP7580-KPL-**-RCI	TP7580R-KPL-**-RCI	Roller	900			
		Steel	TP7580-KPL-**-STL	TP7580R-KPL-**-STL	Roller	2500			
		Ductile Iron	TP7580-KPL-**-SDI	TP7580R-KPL-**-SDI	Roller	5400			
10	3	Polyurethane / Cast Iron	TP7510-KPL-**-PCI	TP7510R-KPL-**-PCI	Roller	3000	12-1/2	8-3/8	3-3/8
		Phenolic	TP7510-KPL-**-PHN	TP7510R-KPL-**-PHN	Roller	2900			
		Rubber / Cast Iron	TP7510-KPL-**-RCI	TP7510R-KPL-**-RCI	Roller	1000			
		Steel	TP7510-KPL-**-STL	TP7510R-KPL-**-STL	Roller	2500			
		Ductile Iron	TP7510-KPL-**-SDI	TP7510R-KPL-**-SDI	Roller	5400			
12	3	Polyurethane / Cast Iron	TP7512-KPL-**-PCI	TP7512R-KPL-**-PCI	Roller	3200	15-1/2	10-5/16	4-5/16
		Phenolic	TP7512-KPL-**-PHN	TP7512R-KPL-**-PHN	Roller	3500			
		Rubber / Cast Iron	TP7512-KPL-**-RCI	TP7512R-KPL-**-RCI	Roller	1200			
		Steel	TP7512-KPL-**-STL	TP7512R-KPL-**-STL	Roller	2500			
		Ductile Iron	TP7512-KPL-**-SDI	TP7512R-KPL-**-SDI	Roller	5400			

Fastening

TYPE	CODE	SIZE (Inch)	
Top Plate	KPL-01	Overall Size	4-1/4 x 6-1/4 x 3/8
		Bolt Hole Spacing	2-7/16 x 4-15/16 slotted to 3-3/8 x 5-1/4
		Attaching Bolt Size	1/2"
	KPL-02	Overall Size	5-1/4 x 7-1/4 x 3/8
		Bolt Hole Spacing	3-3/8 x 5-1/4 slotted to 4-1/8 x 6-1/8
		Attaching Bolt Size	1/2"

Options

CODE	DESCRIPTION
WB	Wheel Brake
PSL	4 Position Swivel Lock

Add Option Code to end of part number.

Replace -**- in part number with appropriate fastening code.

Heavy Duty Drop Forged Casters

TP7500 Series / Capacity up to 5400 Lbs.



Features

- **Finish:** Bright zinc plating
- **Top Plate:** 13/32" AISI 1045 drop forged steel for maximum strength
- **Swivel:** Double ball bearing coined "deep-groove" load and machined component trust raceway
- **Rigid:** Welded with heavy duty gauge street for extra strength
- **Fork Spacing:** 3-1/2"
- **Legs:** 3/8" steel, machine welded, engineered and formed to resist bending.
- **Kingpin:** 3/4" diameter bolt and nut
- **Grease Fittings:** Zerk in swivel section
- **Axle:** 3/4" diameter axle with lock nut

Applications

- Cargo Containers
- Freight Terminal Trucks
- Textile Carts & Storage Racks
- Trash Containers
- Heavy Duty Platform Trucks

Caster Options

- **WB:** Wheel Brake



- **PSL:** 4-Position Swivel Lock



Wheel Diameter	Tread Width	Wheel Type	Swivel Number	Rigid Number	Wheel Bearing	Load Capacity	Overall Height	Swivel Radius
6	3	Polyurethane / Cast Iron	TP7560-01-PCI	TP7560R-01-PCI	Roller	2000	7-1/2	5-3/16
		Phenolic	TP7560-01-PHN	TP7560R-01-PHN	Roller	2000		
		Rubber / Cast Iron	TP7560-01-RCI	TP7560R-01-RCI	Roller	750		
		Steel	TP7560-01-STL	TP7560R-01-STL	Roller	2500		
		Ductile Iron	TP7560-01-SDI	TP7560R-01-SDI	Roller	4800		
8	3	Polyurethane / Cast Iron	TP7580-01-PCI	TP7580R-01-PCI	Roller	2500	10-1/8	6-3/16
		Phenolic	TP7580-01-PHN	TP7580R-01-PHN	Roller	2500		
		Rubber / Cast Iron	TP7580-01-RCI	TP7580R-01-RCI	Roller	900		
		Steel	TP7580-01-STL	TP7580R-01-STL	Roller	2500		
		Ductile Iron	TP7580-01-SDI	TP7580R-01-SDI	Roller	5400		
10	3	Polyurethane / Cast Iron	TP7510-01-PCI	TP7510R-01-PCI	Roller	3000	11-1/2	7-9/16
		Phenolic	TP7510-01-PHN	TP7510R-01-PHN	Roller	2900		
		Rubber / Cast Iron	TP7510-01-RCI	TP7510R-01-RCI	Roller	1000		
		Steel	TP7510-01-STL	TP7510R-01-STL	Roller	2500		
		Ductile Iron	TP7510-01-SDI	TP7510R-01-SDI	Roller	5400		
12	3	Polyurethane / Cast Iron	TP7512-01-PCI	TP7512R-01-PCI	Roller	3200	13-1/2	8-9/16
		Phenolic	TP7512-01-PHN	TP7512R-01-PHN	Roller	3500		
		Rubber / Cast Iron	TP7512-01-RCI	TP7512R-01-RCI	Roller	1200		
		Steel	TP7512-01-STL	TP7512R-01-STL	Roller	2500		
		Ductile Iron	TP7512-01-SDI	TP7512R-01-SDI	Roller	5400		

Fastening

TYPE	CODE	SIZE (Inch)	
Top Plate	01	Overall Size	5-1/4 x 7-1/4 x 3/8
		Bolt Hole Spacing	3-3/8 x 5-1/4 slotted to 4-1/8 x 6-1/8
		Attaching Bolt Size	1/2"

Replace -** - in part number with appropriate fastening code.

Options

CODE	DESCRIPTION
WB	Wheel Brake
PSL	4 Position Swivel Lock

Add Option Code to end of part number

TP7500 KPL Series

Super Heavy Duty Casters

TP7600 Series / Capacity up to 4400 Lbs.



Features

- **Finish:** Bright zinc plating
- **Swivel:** Precision sealed ball bearing eliminates need for routine maintenance (Thrust Bearing #51117 & Taper Roller Bearing # #30206)
- **Rigid:** Welded with heavy duty gauge steel for extra strength
- **Top Plate:** 15/32" steel plate
- **Fork Spacing :** 3-1/4"
- **Legs:** 23/64" steel, machine welded, engineered and formed to resist bending.
- **Kingpin:** 1" diameter bolt and nut
- **Axle:** 3/4" diameter axle with lock nut

Applications

- Cargo Containers
- Freight Terminal Trucks
- Textile Carts & Storage Racks
- Trash Containers
- Heavy Duty Platform Trucks

Wheel Diameter	Tread Width	Wheel Type	Swivel Number	Rigid Number	Wheel Bearing	Load Capacity	Overall Height	Swivel Radius
6	2-1/2	Polyurethane / Aluminum	TP7660-01-PAL	TP7660R-01-PAL	Precision Ball	3300	8-7/8	4-13/16
8	2-1/2	Polyurethane / Aluminum	TP7680-01-PAL	TP7680R-01-PAL	Precision Ball	4400	10-13/16	6-1/4

Fastening			
TYPE	CODE	SIZE (Inch)	
Top Plate	01	Overall Size	6-7/8 x 5-1/2
		Bolt Hole Spacing	5-13/16 x 4-3/8 slotted to 5-3/16 x 3-7/8
		Attaching Bolt Size	1/2"

Replace -*- in part number with appropriate fastening code.

Options	
CODE	DESCRIPTION
WB	Wheel Brake
PSL	4 Position Swivel Lock

Add Option Code to end of part number.

Caster Options

- WB: Wheel Brake
- PSL: 4-Position Swivel Lock

- Rigid

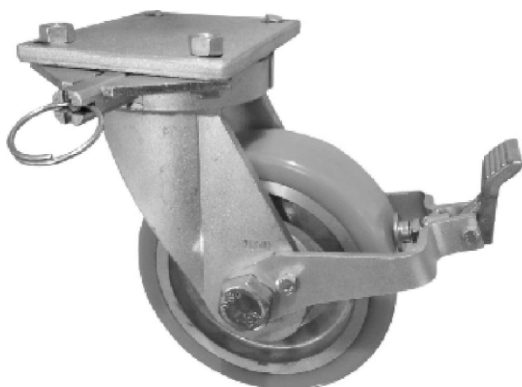

TP7600 Series

Low-Profile Machines Casters

TP8000 Series / Capacity up to 300 Lbs.



Features

- **Finish:** Bright zinc plating
- **Swivel:** Double ball bearing raceways
- **Construction:** Low-profile design
- **Axle:** 5/16" diameter axle with lock nut

Applications

- Office Equipment
- Display Stand Racks
- Institutional Equipment
- Light Duty Vending Machines

Caster Options

- SLB: Side Lock Brake



Wheel Diameter	Tread Width	Wheel Type	Swivel Number	Wheel Bearing	Load Capacity	Overall Height	Swivel Radius
1-7/16	5/8 each	Heavy Duty Plastic	TP8015-**-HDP	Plain	200	2-1/8	1-3/8
		Nylon	TP8015-**-NYL				
2	1-11/16	Heavy Duty Plastic	TP8020-**-HDP	Plain	300	2-13/16	1-7/8
2	3/4 each	Mirage (TPR)	TP8022-**-MIR	Plain	160	2-13/16	1-7/8
		Soft Rubber	TP8022-**-SR				
		Hard Rubber	TP8022-**-HR		200		

Replace -**- in part number with appropriate fastening code.

Fastenings			
TYPE	CODE	SIZE (Inch)	
Top Plate	01	Overall Size	2-3/4 x 3-3/4
		Bolt Hole Spacing	1-3/4 x 2-7/8
		Attaching Bolt Size	5/16
	02	Overall Size	1-7/8 x 2-9/16
Bolt Hole Spacing		15/16 x 2-1/8	
Attaching Bolt Size		1/4	
Grip Ring Stem	11	7/16 x 1-7/16	
Threaded Stem	20	1/2 - 13 x 1	
	21	1/2 - 13 x 1-1/2	
	26	3/8 - 16 x 3/4	
	27	3/8 - 16 x 1	

Replace -**- in part number with appropriate fastening code.

Options	
CODE	DESCRIPTION
CR	Chrome Plating
AC	Antique Copper
TSB	Thumb Screw Brake
SLB	Side Lock Brake
FLB	Front Lock Brake

Add Option Code to end of part number



TP8020-01-HDP

Business Machine Casters

TP8000 Series / Capacity up to 1000 Lbs.

TP8000 Series



Features

- **Finish:** Bright zinc plating
- **Swivel:** Double ball bearing raceways
- **Construction:** Provides floor protection and excellent mobility
- **SLB:** Side Lock Brake standard
- **Axle:** Standard : 3/8" diameter axle with lock nut
- **Heavy Duty:** 1/2" diameter axle with lock nut
- **Top Plate Thickness:** Standard 5/32", Heavy duty 1/4"

Applications

- Office Equipment
- Business and Vending Machines

Caster Options

- TSB: Thumb Screw Brake



Wheel Diameter	Tread Width	Wheel Type	Swivel Number	Wheel Bearing	Load Capacity	Overall Height	Swivel Radius
Standard Duty - up to 600 lbs							
3	1-13/16	Heavy Duty Plastic	TP8030-03-HDP-SLB	Plain	600	4-1/16	2-5/16
		Glass-Filled Nylon	TP8030-03-NGF-SLB	Roller			
		Phenolic	TP8030-03-PHN-SLB	Roller			
4	1-13/16	Heavy Duty Plastic	TP8040-03-HDP-SLB	Ball	700	5-1/8	3-5/32

Fastenings			
TYPE	CODE	SIZE (Inch)	
Top Plate	03	Overall Size	3-1/8 x 4-1/8
		Bolt Hole Spacing	2-3/8 x 3-3/8
		Attaching Bolt Size	5/16

Options	
CODE	DESCRIPTION
TSB	Thumb Screw Brake
SLB	Side Lock Brake

Add Option Code to end of part number.

Replace -** - in part number with appropriate fastening code.

TP8030-03-NGF-SLB-HD

Shopping Cart Casters

TP8100 Series / Capacity up to 250 Lbs.



Features

- **Finish:** Bright zinc plating
- **Swivel:** Double ball bearing raceways with seal
- **Keylock:** Keylock standard with threaded stem
- **Axle:** 5/16" diameter axle with lock nut

Applications

- Shopping Carts

Caster Options

Wheel Diameter	Tread Width	Wheel Type	Swivel Number	Rigid Number	Wheel Bearing	Load Capacity	Overall Height	Swivel Radius
4	1-1/4	Polyurethane	TP8140-**-PLY	TP8140R-**-PLY	Ball	250	5-3/16	3-3/16
		Polyurethane	TP8140-**-PLY-CB	TP8140R-**-PLY-CB	Center Ball			
		Soft Rubber	TP8140-**-SR	TP8140R-**-SR	Nylon	175		
		Soft Rubber	TP8140-**-SRB	TP8140R-**-SRB	Ball			
5	1-1/4	Polyurethane	TP8150-**-PLY	TP8150R-**-PLY	Ball	250	5-7/8	3-11/16
		Polyurethane	TP8150-**-PLY-CB	TP8150R-**-PLY-CB	Center Ball			
		Soft Rubber	TP8150-**-SR	TP8150R-**-SR	Nylon	200		
		Soft Rubber	TP8150-**-SRB	TP8150R-**-SRB	Ball			

Replace -**- in part number with appropriate fastening code. Add Option Code to end of part number.

Fastenings		
TYPE	CODE	SIZE(Inch)
Front Swivel Casters		
Threaded Stem	21	1/2 - 13 x 9/16 with keylock
	22	1/2 - 20 x 3/4 with keylock
	29	1/2 - 13 x 1 with keylock
Rear Swivel or Rigid Casters		
Round	31	23/32 x 1-9/16 with 2 cross-drilled 1/4" holes at 3/8" and 1-1/4" up from base
	32	13/16 x 1-9/16 with 2 cross-drilled 1/4" holes at 3/8" and 1-1/4" up from base
Plain Stem	34	0.860 x 1-3/4 with 1 cross-drilled 1/4" hole 1-3/16" up from base

Options	
CODE	DESCRIPTION
TG	Plastic Thread Guards

Add Option Code to end of part number.

Replace -**- in part number with appropriate fastening code.



TP8150-31-PLY-TG



TP8150R-31-PLY-TG



TP8150-29-PLY-TG (S)



PLY-5J2-TG (S)



PLY-5J2-CB

Stackable Dolly Casters

TP8200 Series / Capacity up to 300 Lbs.



Features

- **Finish:** Bright zinc plating
- **Swivel:** Double ball bearing raceways
- **Construction:** Developed primarily for stackable dollies
- **Axle:** 3/8" diameter axle with lock nut

Applications

- Stackable Dollies
- Small Containers
- Totes Cases
- Dairy Cases

Caster Options

- SWB: Swivel & Wheel Brake



Wheel Diameter	Tread Width	Wheel Type	Swivel Number	Wheel Bearing	Load Capacity	Overall Height	Swivel Radius
3	1-3/8	Heavy Duty Plastic	TP8230-05-HPB-S0	Ball	250	4	2-1/8
4	1-1/2	Heavy Duty Plastic	TP8240-05-HPB-S0	Ball	300	5	2-7/8

Fastenings			
TYPE	CODE	SIZE(Inch)	
Rectangular Top Plate	05	Overall Size	4-3/32 x 3-7/64
		Bolt Hole Spacing	2-3/8 x 3-3/8 to 3-15/32
		Attaching Bolt Size	3/8

Replace -* *- in part number with appropriate fastening code.

Options	
CODE	DESCRIPTION
SWB	Swivel & wheel Brake (3" only)
WH	White Color
S0	Short Off-Set

Add Option Code to end of part number.



TP8230-05-HPB-S0-WH



TP8240-05-HPB-S0

TP8200 Series

Ladder Casters

TP8300 Series / Capacity up to 125 Lbs.



Features

- **Finish:** Bright zinc plating
- **Swivel:** Double ball bearing raceways
- Extra-long stem for spring/hardware installation (Spring not included)
- **Axle:** 15/64" diameter axle with lock nut

Applications

- Rolling Ladders

Caster Options

Wheel Diameter	Tread Width	Wheel Type	Swivel Number	Wheel Bearing	Load Capacity	Overall Height	Swivel Radius
2	3/4	Soft Rubber	TP8320-21-SR	Nylon	80	2-3/8	1-13/16
		Hard Rubber	TP8320-21-HR	Nylon	100		
3	3/4	Soft Rubber	TP8330-21-SR	Nylon	100	3-1/2	2-3/8
		Hard Rubber	TP8330-21-HR	Nylon	125		
		Soft Rubber	TP8330-22-SR	Nylon	100	3-17/32	2-3/8

Fastenings

TYPE	CODE	SIZE(Inch)	
Threaded Stem	21	Overall Length	4-7/8
		Threaded Diameter	5/16-18 x 5/8
		Top Diameter & Length	5/16 x 2-3/8
	Base Diameter & Length	9/16 x 1-7/8	
	22	Overall Length	1-31/32
		Top Diameter & Length	3/8-16 x 3/4
Base Diameter & Length		9/16 X 1-11/50	

Replace -** - in part number with appropriate fastening code.

Scaffold Casters

TP8900 Series / Capacity up to 800 Lbs.



Features

- **Finish:** Bright zinc plating
- **Swivel:** Double ball bearing raceways
- **Total Lock Brake:** Easy to engage for swivel and wheels
- **King Bolt:** King bolt and nut construction for added strength
- **Grease Fittings:** Zerk in swivel section
- **Axle:** 1/2" diameter axle with lock nut

Applications

- Rolling Scaffolding

Caster Options

- Brake On



- Brake Off



Wheel Diameter	Tread Width	Wheel Type	Swivel Number	Wheel Bearing	Load Capacity	Overall Height	Swivel Radius
5	1-7/16	Soft Rubber	TP8950D-**-SR	Roller	250	6-1/4	4-1/2
6	2	Rubber / Cast Iron	TP8960-**-RCI	Roller	550	7-1/2	5
		Polyurethane / Cast Iron	TP8960-**-PCI	Roller	700		
		Pro-Tech Polyurethane	TP8960-**-PRO	Roller	650		
8	2	Rubber / Cast Iron	TP8980-**-RCI	Roller	600	9-1/4	6-1/4
		Polyurethane / Cast Iron	TP8980-**-PCI	Roller	800		
		Pro-Tech Polyurethane	TP8980-**-PRO	Roller	750		

Fastenings

TYPE	CODE	SIZE(Inch)
Grip Ring	13	1 x 2-3/4" with 7/16 cross-drilled hole 1-1/4 up from base
	31	1-3/8 x 4 with 1/2 cross-drilled hole 2-1/2 up from base
Round Plain Stem	32	1-7/16 x 4 with 1/2 cross-drilled hole 2-1/2 up from base
	33	1-1/4 x 4 with 1/2 cross-drilled hole 2-1/2 up from base

Replace -**- in part number with appropriate fastening code.

Options

CODE	DESCRIPTION
SNP	Snap Pin (5" Only)
TG	Thread Guards
DB	Delrin Bearing
PBB	Precision Ball Bearing

Add Finish Code to end of part number



SNAP PIN



TP8950-12-SR-SWB



TP8980-31-RCI



TP8980-31-PCI

TP8900 Series

Adjustable Leveling Casters

TP9300 Series / Capacity up to 1000 Lbs.



Features

- **Frame:** Aluminum Die Cast
- **Swivel:** Double ball bearing raceways
- **Finish:** Ivory Powder Coated finish for long lasting durability
- **Wheel:** Non-marking MC-Nylon
- **Leveler:** Easy to height adjustment control

Applications

- Assembly equipment
- General machine
- Medical appliances
- Utility stands
- Work Stations

Caster Options

Wheel Diameter	Tread Width	Wheel Type	Swivel Number	Rigid Number	Wheel Bearing	Load Capacity	Overall Height	Swivel Radius
1-3/4	1	Nylon	TP9320-**-NYL	Plain	220	550	2-3/4	2-7/16
2-1/2	1-1/4	Nylon	TP9330-**-NYL	Plain	320	1000	4	3-1/8

Fastenings				
Wheel	TYPE	CODE	SIZE(Inch)	
1-3/4	Stemless	00	12 MM - 1.75 MM pitch / tapped (threaded) hole 5/8" deep (Supplied with 12 MM - 1.75 MM pitch x 35 MM long threaded stem & nut)	
	Top Plate	01	Overall Size	2-7/8 x 2-7/8
			Bolt Hole Spacing	2-5/16 x 2-5/16
			Attaching Bolt Size	1/4
2-1/2	Stemless	00	12 MM - 1.75 MM pitch / tapped (threaded) hole 13/16" deep (Supplied with 12 MM - 1.75 MM pitch x 35 MM long threaded stem & nut) also 55MM long threaded stem & nut available	
	Top Plate	01	Overall Size	3-9/16 x 3-9/16
			Bolt Hole Spacing	2-3/4 x 2-3/4
			Attaching Bolt Size	5/16

Options	
CODE	DESCRIPTION
ZN	Zinc Plating
CR	Chrome Plating
IPC	Ivory Powder Coating

Add Option Code to end of part number.

Replace -**- in part number with appropriate fastening code.

TP9300 Series

New Adjustable Leveling Casters

TP9300 Series / Capacity up to 3300 Lbs.

NEW



Features

- **Frame:** Aluminum Die Cast
- **Swivel:** Double ball bearing raceways
- **Finish:** Ivory Powder Coated finish for long lasting durability
- **Wheel:** Non-marking MC-Nylon
- **Leveler:** Easy to height adjustment control

Applications

- Assembly equipment
- General machine
- Medical appliances
- Utility stands
- Work Stations

Caster Options

Wheel Diameter	Tread Width	Wheel Type	Swivel Number	Wheel Bearing	Load Capacity	Wheel Hright	Leg Height
1-3/4 (45.3mm)	3/4 (18mm)	Nylon 6	TP9340F-01-NYL-IPC	Plain	220# (100Kg)	2-3/4 (71.5mm)	3-1/4 (81.5mm)
1-3/4 (45.3mm)	3/4 (18mm)	Nylon 6	TP9340S-00-NYL-IPC	Plain	220# (100Kg)	2-3/4 (71.5mm)	3-1/4 (81.5mm)
2" (50mm)	31/32" (24.5mm)	Nylon 6	TP9360F-01-NYL-IPC	Plain	550# (250Kg)	3-1/4" (82.5mm)	3-21/32" (92.5mm)
2" (50mm)	31/32" (24.5mm)	Nylon 6	TP9360S-00-NYL-IPC	Plain	550# (250Kg)	3-5/16" (84.5mm)	3-23/32" (94.5mm)
2-1/2" (63mm)	1-3/16" (30mm)	Nylon 6	TP9380F-02-NYL-IPC	Plain	1100# (500Kg)	4-1/8" (104.5mm)	4-19/32 (126.5mm)
2-1/2" (63mm)	1-3/16" (30mm)	Nylon 6	TP9380S-00-NYL-IPC	Plain	1100# (500Kg)	4-1/8" (104.5mm)	4-19/32 (126.5mm)
3" (72mm)	1-1/4" (32mm)	Nylon 6	TP93100F-03-NYL-IPC	Plain	1600# (750Kg)	4-13/16" (122mm)	5-9/32" (134mm)
3" (72mm)	1-1/4" (32mm)	Nylon 6	TP93100S-00-NYL-IPC	Plain	1600# (750Kg)	4-13/16" (122mm)	5-9/32" (134mm)
3" (72mm)	1-1/4" (32mm)	Nylon 6	TP93120F-03-NYL-IPC	Plain	1600# (750Kg)	4-13/16" (122mm)	5-1/2" (139.5mm)
3" (72mm)	1-1/4" (32mm)	Nylon 6	TP93120S-00-NYL-IPC	Plain	1600# (750Kg)	4-13/16" (122mm)	5-1/2" (139.5mm)
3-1/2" (90.5mm)	2-1/8" (55mm)	Mc Nylon	TP93150F-04-NYL-IPC	Plain	3300# (1500Kg)	5-1/8" (130mm)	6-1/8" (155mm)

Fastenings

TYPE	CODE	Series	SIZE(Inch)
Top Plate	01	TP9340F	Overall Size 2-7/8 x 2-7/8 (73mm x 73mm)
		TP9360F	Bolt Hole Spacing 2-1/4 x 2-1/4 (58mm x 58mm)
			Attaching Bolt Size 1/4 (6.7mm)
	02	TP9380F	Overall Size 3-1/2 x 3-1/2 (90mm x 90mm)
			Bolt Hole Spacing 2-3/4 x 2-3/4 (70mm x 70mm)
			Attaching Bolt Size 11/32 (9mm)
	03	TP93100F / TP93120F	Overall Size 3-1/4 x 3-1/4 (95mm x 95mm)
			Bolt Hole Spacing 2-3/4 x 2-3/4 (70mm x 70mm)
			Attaching Bolt Size 7/16 (11mm)
	04	TP93150F	Overall Size 4 x 4 (100mm x 100mm)
			Bolt Hole Spacing 2-3/4 x 2-3/4 (70mm x 70mm)
			Attaching Bolt Size 1/2 (13mm)
Stemless	-00-	TP9340S	Hole Size Center Hole M8 Tap DP12
			Screw Size M8 x 1"
		TP9360S / TP9380S	Hole Size Center Hole M12 Tap DP15
			Screw Size M12 x 1-3/8"
		TP93100S / TP93120S	Hole Size Center Hole M16 Tap DP16
			Screw Size M16 x 1-3/4"

Options

CODE	DESCRIPTION
ZN	Zinc Plating
CR	Chrome Plating
IPC	Ivory Powder Coating

Add Option Code to end of part number.



TP9360F-01-NYL-IPC



TP9360S-00-NYL-IPC

Replace *- *- in part number with appropriate fastening code.

TP9300 Series

Leveling Casters

TP9500 Series / Capacity up to 700 Lbs.



Features

- **Finish:** Flat-Black finish
- **Swivel:** Double ball bearing raceways
- **Side-mounted adjustable leveler**
- **Axle:** 5/16" diameter axle with lock nut

Applications

- Electronic Machinery
- Heavy Duty Equipment

Caster Options

- Leveler



Wheel Diameter	Tread Width	Wheel Type	Swivel Number	Rigid Number	Wheel Bearing	Load Capacity	Overall Height	Swivel Radius
2	1-1/4	M.C. Nylon	TP9520-01-MCN	-	Precision Ball	700	3-1/16	1-11/16

Fastenings			
TYPE	CODE	SIZE(Inch)	
Top Plate	01	Overall Size	3-1/4 x 3-1/4
		Bolt Hole Spacing	2-3/16 x 2-3/16 slotted to 2-9/16 x 2-9/16
		Attaching Bolt Size	3/8

Options	
CODE	DESCRIPTION
Lev-9520	Leveler Kit 9520

Add Option Code to end of part number.

Replace -*- in part number with appropriate fastening code.

TP9500 Series

Auto Ind. / Maintenance Free Casters

TP6600MF~TP6601MF Series / Capacity up to 1300 Lbs.



Features

- Ergonomic Designed for easy swiveling and noise reduction
- **Finish:** Bright zinc plating
- **Top Plate:** 1/4" steel plate
- **Swivel:** Precision sealed ball bearing #6007ZZ
- **Fork Spacing:** 2-1/2"
- **Leg Thickness:** 1/4" steel plate
- **Axle:** 1/2" diameter axle with lock nut

Applications

- Auto Pallets
- Military Equipment
- Tractor Pulled Trailers
- Air Cargo & Ground Support
- Tow Line & Shock Load Applications
- Platform Trucks & Freight Terminal Dollies

Caster Options

- Sealed Precision Raceway



- Maintenance-Free operation offers both long-term durability and peace of mind.
- Kingpinless technology provides the highest level of swivel strength.
- Available in both swivel and rigid (fixed) models, and in 6" and 8" wheel diameters.
- Polyurethane tread offers strength, durability and ultimate floor protection.
- Cast Iron wheel center gives crucial solid core strength.
- Precision bearings in the swivel provide the ultimate smooth operation.

Wheel Diameter	Tread Width	Wheel Type	Swivel Number	Rigid Number	Wheel Bearing	Load Capacity	Overall Height	Swivel Radius
4	2	Crown Polyurethane	TP6640MF-**-PALC-PBB	TP6640RMF-**-PALC-PBB	Precision	600	5-5/8	3-9/16
5	2	Crown Polyurethane	TP6650MF-**-PALC-PBB	TP6650RMF-**-PALC-PBB	Precision	800	6-1/2	4-1/4
6	2	Crown Polyurethane	TP6661MF-**-PALC-PBB	TP6661RMF-**-PALC-PBB	Precision	1200	7-1/2	4-5/8
		Polyurethane	TP6661MF-**-PCIS-PBB	TP6661RMF-**-PCIS-PBB	Precision	1200		
8	2	Crown Polyurethane	TP6680MF-**-PALC-PBB	TP6680RMF-**-PALC-PBB	Precision	1300	9-1/2	6-1/2
		Polyurethane	TP6680MF-**-PCIS-PBB	TP6680RMF-**-PCIS-PBB	Precision	1300		
		Crown Polyurethane	TP6681MF-**-PALC-PBB	TP6681RMF-**-PALC-PBB	Precision	1300	10-1/2	6-1/4
		Polyurethane	TP6681MF-**-PCIS-PBB	TP6681RMF-**-PCIS-PBB	Precision	1300		

*Precision Ball Bearing: Swivel Raceway #6007ZZ / Wheel: #6203-2RS

Fastenings				
TYPE	CODE	MODEL	SIZE (Inch)	
Top Plate	MF-01	TP6661MF	Overall Size	4 x 4-1/2
			Bolt Hole Spacing	3-5/8 x 3-5/8 slotted to 3 x 3
			Attaching Bolt Size	3/8
	MF-07	TP6661MF	Overall Size	4-1/2 x 6-1/4
Bolt Hole Spacing			2-7/16 x 4-15/16 slotted to 3-3/8 x 5-1/4	
Attaching Bolt Size			1/2	

Replace -** - in part number with appropriate fastening code.

Wheel Options



PALC
(ORANGE)



PALC
(RED)



PALC
(GREEN)



PCC



PRX-PBB

TP6601MF Series

Auto Ind. / Maintenance Free Casters

TP7002 MF Series / Capacity up to 1500 Lbs.



Features

- Ergonomic Designed for easy swiveling and noise reduction
- **Finish:** Bright zinc plating
- **Top Plate:** 23/64" steel plate
- **Swivel:** Precision sealed ball bearing #6210-2RS
- **Fork Spacing:** 2-1/2"
- **Leg Thickness:** 1/4" steel plate
- **Axle:** 1/2" diameter axle with lock nut

Applications

- Auto Pallets
- Military Equipment
- Tractor Pulled Trailers
- Air Cargo & Ground Support
- Tow Line & Shock Load Applications
- Platform Trucks & Freight Terminal Dollies

Caster Options

- Maintenance-Free operation offers both long-term durability and peace of mind.
- Kingpinless technology provides the highest level of swivel strength.
- Available in both swivel and rigid (fixed) models, and in 6" and 8" wheel diameters.
- Polyurethane tread offers strength, durability and ultimate floor protection.
- Cast Iron wheel center gives crucial solid core strength.
- Precision bearings in the swivel provide the ultimate smooth operation.

Wheel Diameter	Tread Width	Wheel Type	Swivel Number	Rigid Number	Wheel Bearing	Load Capacity	Overall Height	Swivel Radius	Swivel Lead
6	2	Crown Polyurethane	TP7062MF-**-PALC-PBB	TP7062RMF-**-PALC-PBB	Precision	1200	8-3/32	7-5/8	2-3/4
8	2	Crown Polyurethane	TP7082MF-**-PALC-PBB	TP7082RMF-**-PALC-PBB	Precision	1500	10-1/8	6-3/4	2-3/4

* Swivel Raceway : Precision #6007ZZ / Polyurethan Wheel : #6203-2RS

Fastenings

TYPE	CODE	SIZE (Inch)	
Top Plate	MF-05	Overall Size	4-1/2 x 5
		Bolt Hole Spacing	3 x 4
		Attaching Bolt Size	3/8
	MF-07	Overall Size	4-1/2 x 6-1/4
		Bolt Hole Spacing	2-7/16 x 4-15/16 slotted to 3-3/8 x 5-1/4
		Attaching Bolt Size	1/2

Replace -** - in part number with appropriate fastening code.

Wheel Options

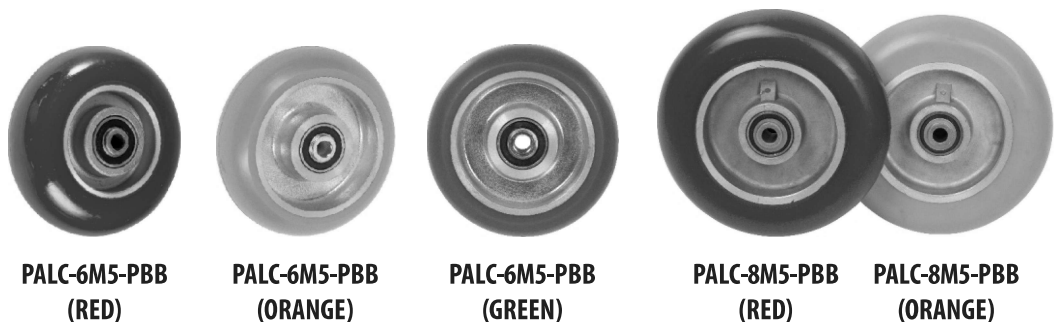

PALC-6M5-PBB
(RED)

PALC-6M5-PBB
(ORANGE)

PALC-6M5-PBB
(GREEN)

PALC-8M5-PBB
(RED)

PALC-8M5-PBB
(ORANGE)

TP7002 MF Series

Shock Absorbing Casters

TP9600SA~TP9601 SA Series / Capacity up to 1200 Lbs.



TP9660-SA-PCC-PBB

Features

- **Finish:** Bright zinc plating
- **Top Plate:** 1/4" steel plate
- **Swivel:** Double ball bearing with hardened raceways for extra strength
- **Fork Spacing:** 2-17/64" (2.265")
- **Leg Thickness:** 1/4" steel plate
- **Axle:** 1/2" diameter axle with lock nut

Applications

- Auto Pallets
- Military Equipment
- Tractor Pulled Trailers
- Air Cargo & Ground Support
- Tow Line & Shock Load Applications
- Platform Trucks & Freight Terminal Dollies

Caster Options

TP9600 Series

Wheel Diameter	Tread Width	Wheel Type	Swivel Number	Rigid Number	Wheel Bearing	Load Capacity	Overall Height	Swivel Radius
6	2	Polyurethane / Cast Iron	TP9660-SA-PCC	TP9660R-SA-PCC	Roller Precision	800	8-1/16	5
		Polyurethane / Cast Iron	TP9660-SA-PCC-PBB	TP9660R-SA-PCC-PBB				
8	2	Polyurethane / Cast Iron	TP9680-SA-PCC	TP9680R-SA-PCC	Roller Precision	1200	10-1/8	6-53/64
		Polyurethane / Cast Iron	TP9680-SA-PCC-PBB	TP9680R-SA-PCC-PBB				

TP9601 Series

Wheel Diameter	Tread Width	Wheel Type	Swivel Number	Rigid Number	Wheel Bearing	Load Capacity	Overall Height	Swivel Radius
6	2	Polyurethane / Cast Iron	TP9661-SA-PCC-PBB	TP9661R-SA-PCC-PBB	Precision Precision	800	7-55/64	5
		Polyurethane / Cast Iron	TP9661-SA-PALC-PBB	TP9661R-SA-PALC-PBB				
8	2	Polyurethane / Cast Iron	TP9681-SA-PCC-PBB	TP9681R-SA-PCC-PBB	Precision Precision	1200	10-1/8	6-53/64
		Polyurethane / Cast Iron	TP9681-SA-PALC-PBB	TP9681R-SA-PALC-PBB				

Overall Height

Wheel Diameter	Tread Width	Part Number	Off Loading	On Loading
6	2	TP9660-SA-PCC-PBB	8-1/16	7-7/16
		TP9661-SA-PCC-PBB	7-55/64	7-1/4
8	2	TP9680-SA-PCC-PBB	10-1/8	9-1/2
		TP9681-SA-PCC-PBB		

Fastening

TYPE	CODE	SIZE (Inch)	
Top Plate	SA	Overall Size	4-1/2 x 6-1/4
		Bolt Hole Spacing	2-7/16 x 4-15/16 slotted to 3-3/8 x 5-1/4
		Attaching Bolt Size	1/2"

Replace -*- in part number with appropriate fastening code.

Options

CODE	DESCRIPTION
Red	Spring Active up to 800 lbs
Yel	Spring Active up to 207 lbs
TG	Thread Guard

Add Option Code to end of part number.

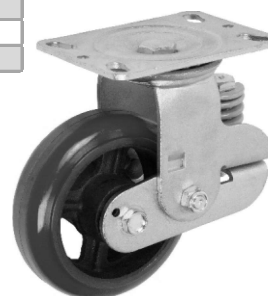

TP9661-SA-PCC-PBB

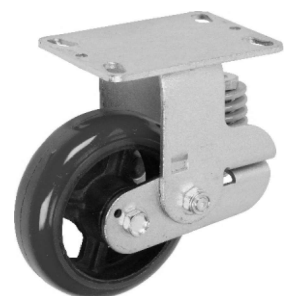

TP9661R-SA-PCC-PBB

TP9600 Series

Medium Duty Nylon Casters

TP5501 Series / Capacity up to 200 Lbs.



Features

- **Body:** PA6 + GF(Nylon)
- **Swivel:** #6203 Precision Ball Bearing
- **Swivel Center Pin:** Ø12.7 (0.5")
- **Axle:** 5/16" Bolt and Nut

Applications

- Electronic Equipment
- Mobile Computer Stand
- Diagnostic Equipment
- Medical Equipment

Wheel Diameter	Tread Width	Wheel Type	Swivel Number	Wheel Bearing	Load Capacity	Overall Height	Swivel Radius
5	1-1/4	Mirage	TP5551-**-MIR	Precision	200	6-3/4 (172mm)	4-3/32(104mm)

Fastenings			
TYPE	CODE	SIZE(Inch)	
Top Plate	01	Overall Size	2-1/2 x 3-5/8 (64 x 92)
		Bolt Hole Spacing	1-3/4 x 2-61/64 (45 x 75)
		Attaching Bolt Size	5/16 (M8)
Threaded Stem	21	1/2-13 x 1	
	23	5/8-11 x 1	
	25	M12-1.75P x 25mm (1")	

Replace -**- in part number with appropriate fastening code.

Options	
CODE	
SWB	Total Lock Swivel and Wheel Brake

Add Option Code to end of part number.

TP5501 Series

Medium Duty Medical Casters

TP8400 Series / Capacity up to 280 Lbs.



Features

TP8430/8440/8450/8460/8480 Series

- Bright Chrome Plated Finish
- **SWB:** Total Lock - Swivel and Wheel
- Directional Lock
(Lock Swivel - Available 5" & 6" Only)
- **Swivel:** Double Ball Swivel Raceway (TP8430/8440/8450)
- Precision Ball Bearing in Raceway and Wheel (8460/8480)

Applications

- Hospital Beds and Equipment
- Medical Equipment
- Laboratory Equipment
- Diagnostic Equipment
- Institutional Equipment
- Movie Equipment
- Computer Equipment



*TP8430 & -00- & PLE & DL & TG Options are not NSF listed.

Wheel Diameter	Tread Width	Wheel Type	Swivel Number	Wheel Bearing	Load Capacity	Overall Height Top Plate	Overall Height Grip Ring	Overall Height Threaded	Overall Height Round Stem	Swivel Radius
3	1-1/4	Mirage (TPR)	TP8430-**-MIR-TG	Precision	110	4-11/16	4-1/4	4-5/8	4-1/4	3-1/8
		Hi Elastic Polyurethane	TP8430-**-PLE	Precision	125					
4		Mirage (TPR)	TP8440-**-MIR-TG	Precision	150	5-3/4	5-5/16	3-3/8	3-3/8	3-5/8
		Hi Elastic Polyurethane	TP8440-**-PLE	Precision	165					
5		Mirage (TPR)	TP8450-**-MIR-TG	Precision	200	6-3/4	6-5/16	6-5/16	n/a	4-1/8
		Hi Elastic Polyurethane	TP8450-**-PLE	Precision	175					
6		Mirage (TPR)	TP8460-**-MIR-TG	Precision	240	8	n/a	8	7-9/16	5-1/4
8		Mirage (TPR)	TP8480-**-MIR-TG	Precision	280	10-1/16	n/a	10	9-5/8	6-7/16

Fastenings

TYPE	CODE	SIZE(Inch)
Stemless	00	Attaching Bolt Size 1/2"
Top Plate	01	Overall Size
		Bolt Hole Spacing
		Attaching Bolt Size
Grip Ring Stem	11	7/16 x 1-7/16
	12	0.845 x 2-7/16
Threaded Stem	21	1/2 - 13 x 1-1/2
	23	3/4 - 11 x 1" with hex nut base
Round Plain Stem	31	1" x 2-1/4 with 2 cross-drilled holes 9/16 and 1-1/4 up from base
	33	1" x 2-1/8 with 2 cross-drilled holes 9/16 and 1-1/4 up from base

Replace -**- in part number with appropriate fastening code.

Options

CODE	DESCRIPTION
SWB	Total Lock Locks both wheel and swivel simultaneously
DL	Directional Lock Locks swivel only, effectively making it a rigid. (Available on 5" & 6" only.)
BR	Brass Finish Bright polished brass finish

Add Option Code to end of part number.

TP8400 Series

Nylon Covered Medical Casters

TP8454 Series / Capacity up to 200 Lbs.



Features

- **TP8454 Series:** Aesthetic shape with Nylon covered
- Precision Ball Bearing in Raceway and Wheel
- **SWB Brake:** Total Lock -Swivel and Wheel
- **Dual Lock System:** Double pedal brake design for easy on/off for directional and total lock.

Applications

- Medical Equipment
- Hospital Beds and Equipment
- Laboratory Equipment
- Diagnostic Equipment
- Mobil Computer Stand
- Movie Equipment

Wheel Diameter	Tread Width	Wheel Type	Swivel Number	Wheel Bearing	Load Capacity	Overall Height	Swivel Radius
5	1-1/4	Elastic Soft Rubber	TP8454-**-TSR-TG	Precision	200	6-3/4	4-3/32
		Elastic Polyurethane	TP8454-**-PLE	Precision	200		

Options

CODE	DESCRIPTION	
CR	Chrome Finish	Bright polished chrome finish
DUL	Dual Lock Brake	Locks the swivel or the wheel, Directional and total Lock
SWB	Swivel Wheel Brake	Locks both the swivel and the wheel
TSR	Plastic Outer Shroud	High elastic rubber Tread / Nylon Center

Add Option Code to end of part number.



TP8454-02-TSR-DUL



TP8454-02-TSR-SWB

TP8454 Series

Deluxe Total Lock Caster

TP8700 Series / Capacity up to 240 Lbs.



Features

- **Finish:** Chrome Plated Finish Standard
- **Swivel:** Double ball swivel raceway
- **SWB Brake:** Total Lock - Swivel and Wheel
- **Axle & Nut:** 5/16" diameter Axle with lock nut

Applications

- Hospital Equipment
- Medical Equipment
- Institutional Equipment
- Movie Equipment
- Food Service

Caster Options

- SWB: Swivel Wheel Brake



Wheel Diameter	Tread Width	Wheel Type	Swivel Number	Rigid Number	Wheel Bearing	Load Capacity	Overall Height	Swivel Radius
3	1-1/4	Mirage (TPR)	TP8730-**-MIR-TG-SWB	TP8730R-01-MIR-TG	Precision Ball	110	4-1/2	3-1/16
		Hi Elastic Polyurethane	TP8730-**-PLE-SWB	TP8730R-01-PLE	Precision Ball	125		
4	1-1/4	Mirage (TPR)	TP8740-**-MIR-TG-SWB	TP8740R-01-MIR-TG	Precision Ball	150	5-1/2	3-3/8
		Hi Elastic Polyurethane	TP8740-**-PLY-SWB	TP8740R-01-PLY	Ball	150		
		Hi Elastic Polyurethane	TP8740-**-PLE-SWB	TP8740R-01-PLE	Precision Ball	165		
5	1-1/4	Mirage (TPR)	TP8750-**-MIR-TG-SWB	TP8750R-01-MIR-TG	Precision Ball	200	6-1/2	3-5/8
		Hi Elastic Polyurethane	TP8750-**-PLY-SWB	TP8750R-01-PLY	Ball	200		
		Hi Elastic Polyurethane	TP8750-**-PLE-SWB	TP8750R-01-PLE	Precision Ball	175		
6	1-1/4	Mirage (TPR)	TP8760-**-MIR-TG-SWB	TP8760R-01-MIR-TG	Precision Ball	240	7-1/2	4-1/8

Fastenings

TYPE	CODE	SIZE(Inch)	
Stemless	00	1/2" hole -- add your own stem	
Top Plate	01	Overall Size	2-3/8 x 3-5/8
		Bolt Hole Spacing	1-3/4 x 2-15/16
		Attaching Bolt Size	5/16
Grip Ring Stem	11	7/16 x 1-7/16	
	12	7/16 x 2	
Threaded Stem	21	1/2 - 13 x 1-1/2	
	23	5/8 - 11 x 1" with hex nut base	
Round Plain Stem	31	1" x 2-1/4 with 2 holes 9/16 and 1-1/4 up from base	
	33	1-1/8 x 2-1/4 with 2 holes 9/16 and 1-1/4 up from base	

Replace -* *- in part number with appropriate fastening code.



TP8700 Series

Twin Wheel Medical Casters

TP8850 Series / Capacity up to 230 Lbs.



Features

- **Body:** Nylon + Glass Fiber
- **Swivel:** #6204ZZ Precision Ball Bearing
- **Axle:** M12 Bolt

Applications

- Electronic Equipment
- Mobile Computer Stand
- Diagnostic Equipment
- Medical Equipment
- Ultrasonic Equipment

Wheel Diameter	Tread Width	Wheel Type	Swivel Number	Wheel Bearing	Load Capacity	Overall Height	Swivel Radius
5	3-11/32	Polyurethane (TPU)	TP8850-**-PLY-SWB	Precision	240	5-15/16	5-5/16

Replace -** - in part number with appropriate fastening code.

Fastenings

TYPE	CODE	SIZE(Inch)
Threaded Stem	2A	M16 x 27mm (1-1/16")
	2B	M12 x 27mm (1-1/16")

Options

CODE	DESCRIPTION
SWB	Swivel Wheel Brake Total Lock- swivel and wheel Brake

Add Option Code to end of part number.

TP8850 Series

Central Locking Casters

TP9400 Series / Capacity up to 300 Lbs.



Features

- **Bearing:** Precision Ball Bearing in Raceway and Wheels
- **Dust Cover:** Protects from dust and water
- Central locking brake design has very positive swivel and direction locking
- **SWB Brake:** Total Lock -Swivel and Wheel
- **Dual Lock System:** Directional and Total Lock
- Stem with 4 x M8 fixing holes to suit all bed layout

Applications

- Hospital Beds
- Care Beds
- Intensive Care Beds

Caster Options

Wheel Diameter	Tread Width	Wheel Type	Swivel Number	Wheel Bearing	Load Capacity	Overall Height	Swivel Radius
6	1-1/4	Elastic Rubber / Nylon	TP9461-31-TSR	Percision	300	6-5/16	4-23/32

Replace -** - in part number with appropriate fastening code.

Fastenings

TYPE	CODE	SIZE(Inch)
Round Plain Stem	31	Stem Diameter 28mm Two locking hole option available Locking hole in line or cross direction of travel for fixing holes

Replace -** - in part number with appropriate fastening code.

Options

CODE	DESCRIPTION	
DUL	Dual Lock Brake	Locks the swivel or the wheel, Directional and total Lock
SWB	Swivel Wheel Brake	Locks both the swivel and the wheel
TSR		High elastic rubber Tread / Nylon Center

Add Option Code to end of part number.

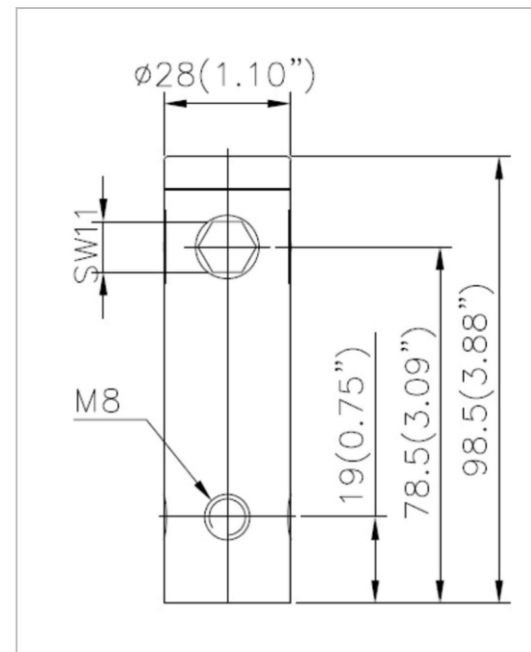

TP9400 Series

Nylon Maintenance Free Medical Casters

TPMC1 Series / Capacity up to 300 Lbs.



Features

- **Body:** Glass filled nylon
- **Bearing:** Precision sealed ball bearing in Raceway and Wheel
- **Brake:** SWB (Total Lock) and DL (Directional Lock) brakes available.
- **Color:** Gray color is standard and custom colors available
- **Wheel:** Non-marking / MIR (TPR)

Applications

- Animal Cage Carts
- Food Service Equipment
- Institutional Equipment
- Medical Equipment
- Utility Carts
- Wash down applications

Caster Options

- SWB - Total Lock Swivel & Wheel Brake



- DL - Directional Lock



Wheel Diameter	Tread Width	Wheel Type	Swivel Number	Wheel Bearing	Load Capacity	Overall Height	Swivel Radius
3	1-1/4	Mirage (TPR)	TPMC1-30-**-MIR	Precision	200	4-3/4	3-41/64
4	1-1/4	Mirage (TPR)	TPMC1-40-**-MIR	Precision	275	5-7/16	4-19/64
5	1-1/4	Mirage (TPR)	TPMC1-50-**-MIR	Precision	300	7	4-3/8

Fastenings			
TYPE	CODE	SIZE (Inch)	
Top Plate	01	Overall Size	2-1/2 x 3-5/8
		Bolt Hole Spacing	1-3/4 x 2-13/16 slotted to 3-1/16
		Attaching Bolt Size	5/16
Grip Ring	11	7/16 x 7/8	
	12	7/16 x 1-7/16	
Threaded Stem	21	1/2 - 13 x 1	
	22	1/2 - 13 x 1-1/2	

Options	
CODE	DESCRIPTION
SWB	Total Lock Swivel & Wheel Brake
DL	Directional Lock

Add Option Code to end of part number.

Replace -**- in part number with appropriate fastening code.



TP8700 Series

Light Duty Plastic Wheels

LDP Wheels / Capacity up to 250 Lbs.



Features

- Injection molded Polyolefin/Polypropylene
- High impact strength
- Economical - less expensive than steel and phenolics
- Unaffected by most chemicals, solvents, oils, and does not absorb water
- Non-marking and light in weight
- Black is standard, other colors available -- call for info
- **Bearings:** Plain bore, delrin, ball, precision ball or roller bearings
- **Temperature range:** -20° F to +190° F

Wheel Diameter	Tread Width	Hub Length	Bearing ID	Wheel Bearing	Wheel Number	Load Capacity	For Caster
2	1	1-1/8	1/4	Plain	LDP-2B1	125	TP3220, TP4020
2-1/2	1-1/16	1-3/8	5/16	Plain	LDP-25F2	175	TP4025
3	1	1-1/8	1/4	Plain	LDP-3B1	150	TP3230
		1-3/16	5/16	Plain	LDP-3D2	150	TP3630
	1-1/4	1-9/16	3/8	Plain	LDP-3H3	210	TP4030, TP5030, TP5130, TP5230
4	1	1-3/16	5/16	Plain	LDP-4D2	175	TP3640
	1-1/4	1-9/16	3/8	Plain	LDP-4H3	225	TP5040, TP5140, TP5240, TP5340
5	1	1-3/16	5/16	Plain	LDP-5D2	200	TP3650
	1-1/4	1-9/16	3/8	Plain	LDP-5H3	250	TP5050, TP5150, TP5250, TP5350

Note: The load capacity for wheels only may be higher than when used in a caster.

Nylon Wheels

NYL Wheels / Capacity up to 800 Lbs.



Features

- Heavy duty injection-molded nylon material
- Resists solvents, and works well in corrosive environments
- Perfect for clean rooms
- Super-ergonomic - rolls and swivels easily
- **Bearings:** Plain bore, delrin, ball, precision ball or roller bearings
- **Durometer:** 75 Shore D (±5)
- **Temperature range:** -40° F to +210° F

Wheel Diameter	Tread Width	Hub Length	Bearing ID	Wheel Bearing	Wheel Number	Load Capacity	For Caster
3	1-3/8	1-5/8	3/8	Plain	NYL-3G3	300	TP4030, TP5030, TP5130, TP5230
4	1-3/8	1-5/8	3/8	Plain	NYL-4K3	375	TP5040, TP5140, TP5240, TP5340
			1-3/16	(w/o bearing)	NYL-4M0	550	TP6640, TP6740
	3/4	Roller	NYL-4M7				
5	1-3/8	1-7/8	3/8	Plain	NYL-5K3	450	TP5050, TP5150, TP5250, TP5350
			1-3/16	(w/o bearing)	NYL-5M0	650	TP6650, TP6750, TP6850, TP7050
	3/4	Roller	NYL-5M7				
6	2	2-7/16	1-3/16	(w/o bearing)	NYL-6M0	700	TP6660, TP6760, TP6860, TP7060
			3/4	Roller	NYL-6M7		
8	2	2-7/16	1-3/16	(w/o bearing)	NYL-8M0	800	TP6680, TP6780, TP6880, TP7080
			3/4	Roller	NYL-8M7		

Note: The load capacity for wheels only may be higher than when used in a caster.

Heavy Duty Plastic Wheels

HDP/HPB/HPR Wheels / Capacity up to 800 Lbs.



Features

- Injection molded Polyolefin/Polypropylene
- High impact strength
- Economical - less expensive than steel and phenolics
- Unaffected by most chemicals, solvents, oils and does not absorb water
- Non-marking and light in weight
- Black is standard, white optional
- **Bearings:** Plain bore, delrin, ball, precision ball or roller bearings
- **Temperature range:** -20° F to +190° F

Wheel Diameter	Tread Width	Hub Length	Bearing ID	Wheel Bearing	Wheel Number	Load Capacity	For Caster
2	1-11/16	1-7/8	5/16	Plain	HDP-2A9	200	TP8020
3	1-3/8	1-5/8	3/8	Plain	HDP-3G3	300	TP4030, TP5030, TP5130, TP5230
			3/8	Ball	HPB-3H3		
	1-13/16	2	5/8	Plain	HDP-3L6		
4	1	1-3/16	5/16	Plain	HDP-4D2	300	TP3640
	1-3/8	1-5/8	3/8	Ball	HPB-4H3	400	TP5040, TP5140, TP5240, TP5340
			3/8	Plain	HDP-4K3		
	1-1/2	1-7/8	1/2	Plain	HDP-4K5		
	1-1/4	1-15/16	1/2	Ball	HPB-4K5		
			1/2	Plain	HDP-4L4	550	TP4040
2	2-7/16	1-3/16	(w/o bearing)	HPR-4M0			
		3/4	Roller	HPR-4M7			
5	1	1-3/16	5/16	Plain	HDP-5D2	375	TP3650
	1-3/8	1-5/8	3/8	Ball	HPB-5H3	450	TP5050, TP5150, TP5250, TP5350
		1-7/8	3/8	Plain	HDP-5K3		
	1-1/2	1-7/8	1/2	Plain	HDP-5K5		
			1/2	Ball	HPB-5K5		
	2	2-7/16	1/2	Plain	HDP-5M5	700	TP6650, TP6750, TP6850
1-3/16			(w/o bearing)	HPR-5M0			
3/4	Roller	HPR-5M7					
6	1-1/2	1-7/8	1/2	Plain	HDP-6K5	600	TP6260, TP6460
			1/2	Ball	HPB-6K5		
	2	2-7/16	1/2	Plain	HDP-6M5	700	TP6660, TP6760, TP6860, TP7060
			1-3/16	(w/o bearing)	HPR-6M0		
			3/4	Roller	HPR-6M7		
8	2	2-7/16	1/2	Plain	HDP-8M5	800	TP6680, TP6780, TP6880, TP7080
			1-3/16	(w/o bearing)	HPR-8M0		
			3/4	Roller	HPR-8M7		

Note: The load capacity for wheels only may be higher than when used in a caster.

Nylon Glass-Field Wheels

NGF Wheels / Capacity up to 1,400 Lbs.



Features

- Special fiberglass - infuse nylon withstands heavy loads
- Very ergonomic - Rolls and swivels easily
- Won't absorb water, resists solvents and chemicals
- **Bearings:** Plain bore, delrin, precision ball or roller bearings
- **Durometer:** 85 Shore D (±5)
- **Temperature range:** -40° F to + 180° F

Wheel Diameter	Tread Width	Hub Length	Bearing ID	Wheel Bearing	Wheel Number	Load Capacity	For Caster
3	1-13/16	1-15/16	1-3/16	(w/o bearing)	NGF-3L0	1000	TP8030 HD
			5/8	Roller	NGF-3L6		
4	2	2-7/16	1-3/16	(w/o bearing)	NGF-4M0	800	TP6640, TP6740
			3/4	Roller	NGF-4M7		
5	2	2-7/16	1-3/16	(w/o bearing)	NGF-5M0	1000	TP6650, TP6750, TP6850
			3/4	Roller	NGF-5M7		
6	2	2-7/16	1-3/16	(w/o bearing)	NGF-6M0	1200	TP6660, TP6760, TP6860, TP7060
			3/4	Roller	NGF-6M7		
8	2	2-7/16	1-3/16	(w/o bearing)	NGF-8M0	1400	TP6680, TP6780, TP6880, TP7080
			3/4	Roller	NGF-8M7		

Note: The load capacity for wheels only may be higher than when used in a caster.

Retort Wheels

RTR Wheels / Capacity up to 900Lbs.



Features

- Extra heavy loads, difficult rolling situations, constant motion
- Hard plastic wheels won't crack or chip
- Suited for food processing and sanitary maintenance under heavier loads
- Resistant to water, steam cleaning and many chemicals
- Bearings : Plain bore, delrin, ball, precision ball or roller bearings
- Color : White
- Temperature range : -20° F to +290° F

Wheel Diameter	Tread Width	Hub Length	Bearing ID	Wheel Bearing	Wheel Number	Load Capacity	For Caster
4	2	2-7/16	1-3/16	(w/o bearing)	RTR-4M0	700	TP6640, TP6740
			3/4	Roller	RTR-4M7		
5	2	2-7/16	1-3/16	(w/o bearing)	RTR-5M0	800	TP6650, TP6750, TP6850
			3/4	Roller	RTR-5M7		
6	2	2-7/16	1-3/16	(w/o bearing)	RTR-6M0	850	TP6660, TP6750, TP6860, TP7060
			3/4	Roller	RTR-6M7		
8	2	2-7/16	1-3/16	(w/o bearing)	RTR-8M0	950	TP6680, TP6780, TP6880, TP7080
			3/4	Roller	RTR-8M7		

Note: The load capacity for wheels only may be higher than when used in a caster.

Mirage Rubber Wheels (TPR)

MIR Wheels / Capacity up to 600 Lbs.

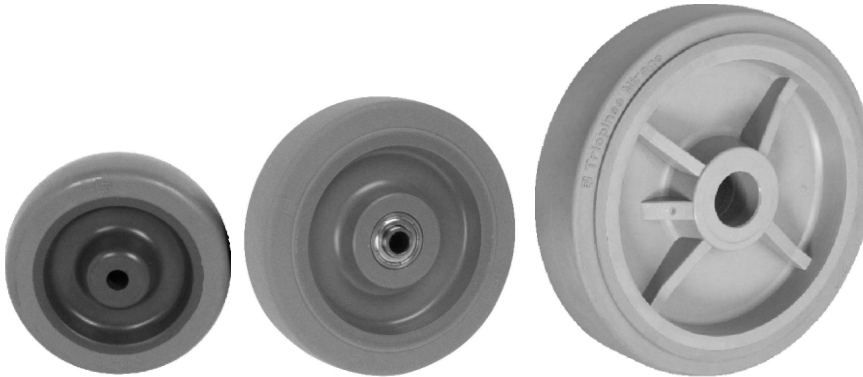

Features

- Thermoplastic rubber tread chemically bonded to a high-impact polypropylene core
- Non-marking and floor protective
- Rolls like rubber, acts like polyurethane
- Better load capacities than standard rubber
- **Bearings:** Annular, Precision, Plain bore, and Roller Bearings
- **Durometer:** 95 Shore A (±5), 75 Shore A (±5)
- **Temperature range:** -20° F to 180° F

Wheel Diameter	Tread Width	Hub Length	Bearing ID	Wheel Bearing	Wheel Number	Load Capacity	For Caster
2	3/4	7/8	15/64	Plain	MIR-2A0	80	TP3020, TP8320
	3/4	7/8	1/4	Plain	MIR-2A8	66	TP8022
		1	1/4	Plain	MIR-2B1	90	TP3220, TP4020
3	13/16	7/8	15/64	Plain	MIR-3A0	100	TP3030
	1	1-3/16	5/16	Plain	MIR-3D2	120	TP3630
	1-1/4	1-9/16	3/8	Plain	MIR-3H3-PB	200	TP4030, TP5030, TP5230
	1-1/4	1-5/8	3/8	Precision	MIR-3G3	225	
	1-1/4	1-5/8	3/8	Precision	MIR-3G3-CB	225	
3-1/2	1-1/4	1-7/16	3/8	Precision	MIR-35G3	250	TP5035, TP5130, TP5235, TP5340
	1-1/4	1-7/16	3/8	Precision	MIR-35G3-CB	250	
4	1	1-3/16	5/16	Plain	MIR-4D2	130	TP3640
	1-1/4	1-9/16	3/8	Plain	MIR-4H3-PB	250	TP5040, TP5140, TP5240, TP5340
	1-1/4	1-5/8	3/8	Precision	MIR-4G3	250	
	1-1/4	1-5/8	3/8	Precision	MIR-4G3-CB	250	
	2	2-3/16	1-3/16	(w/o bearing)	MIR-4M0	350	TP6640, TP6740
	2	2-7/16	3/4	Roller	MIR-4M7	350	
	2	2-7/16	1/2	Precision	MIR-4M5-PBB	350	
2	2-7/16	3/4	Delrin	MIR-4M7-DB	350		
5	1	1-3/16	5/16	Plain	MIR-5D2	140	TP3650
	1-1/4	1-9/16	3/8	Plain	MIR-5H3-PB	275	TP5050, TP5150, TP5250, TP5350
	1-1/4	1-5/8	3/8	Precision	MIR-5G3	275	
	1-1/4	1-5/8	3/8	Precision	MIR-5G3-CB	275	
	2	2-3/16	1-3/16	(w/o bearing)	MIR-5M0	400	TP6650, TP6750, TP6850, TP7050
	2	2-7/16	3/4	Roller	MIR-5M7	400	
	2	2-7/16	1/2	Precision	MIR-5M5-PBB	400	
2	2-7/16	3/4	Delrin	MIR-5M7-DB	400		
6	2	2-3/16	1-3/16	(w/o bearing)	MIR-6M0	500	TP6660, TP6760, TP6860, TP7060
	2	2-7/16	3/4	Roller	MIR-6M7	500	
	2	2-7/16	1/2	Precision	MIR-6M5-PBB	500	
	2	2-7/16	3/4	Delrin	MIR-6M7-DB	500	
8	2	2-3/16	1-3/16	(w/o bearing)	MIR-8M0	600	TP6680, TP6780, TP6880, TP7080
	2	2-7/16	3/4	Roller	MIR-8M7	600	
	2	2-7/16	1/2	Precision	MIR-8M5-PBB	600	
	2	2-7/16	3/4	Delrin	MIR-8M7-DB	600	

Note: The load capacity for wheels only may be higher than when used in a caster.

Crowned Mirage Rubber Wheels (TPR)

MRC / Capacity up to 600 Lbs.



Features

- Crowned thermoplastic rubber tread chemically bonded to a high-impact polypropylene core
- Non-marking and floor protective
- Crown tread helps both swiveling and rolling
- **Bearings:** Delrin, Plain, Precision and Roller Bearing
- **Durometer:** 95 Shore A (±5), (75 Durometer available)
- **Temperature range:** -20° F to 180° F

Wheel Diameter	Tread Width	Hub Length	Bearing ID	Wheel Bearing	Wheel Number	Load Capacity	For Caster
3	1-1/4	1-39/64	3/8	Precision	MRC-3G3-CB	220	TP5030, TP5230, TP5330, TP5430
4	1-1/4	1-39/64	3/8	Precision	MRC-4G3-CB	250	TP5040, TP5240, TP5340, TP5400
4	2	2-3/16	1-3/16	(w/o bearing)	MRC-4M0	350	TP6640, TP6740
			3/4	Roller	MRC-4M7		
		2-7/16	1/2	Precision	MRC-4M5-PBB		
			1/2	Delrin	MRC-4M5-DB		
			3/4	Delrin	MRC-4M7-DB		
5	2	1-1/4	1-39/64	Precision	MRC-5G3-CB	280	TP5050, TP5250, TP5350, TP5450
			2-3/16	1-3/16	(w/o bearing)		
		2-7/16	3/4	Roller	MRC-5M7		
			1/2	Precision	MRC-5M5-PBB		
			1/2	Delrin	MRC-5M5-DB		
			3/4	Delrin	MRC-5M7-DB		
6	2	2-3/16	1-3/16	(w/o bearing)	MRC-6M0	500	TP6660, TP6760, TP6860, TP7060
			3/4	Roller	MRC-6M7		
		2-7/16	1/2	Precision	MRC-6M5-PBB		
			1/2	Delrin	MRC-6M5-DB		
			3/4	Delrin	MRC-6M7-DB		
8	2	2-3/16	1-3/16	(w/o bearing)	MRC-8M0	600	TP6680, TP6780, TP6880, TP7080
			3/4	Roller	MRC-8M7		
		2-7/16	1/2	Precision	MRC-8M5-PBB		
			1/2	Delrin	MRC-8M5-DB		
			3/4	Delrin	MRC-8M7-DB		

Note: The load capacity for wheels only may be higher than when used in a

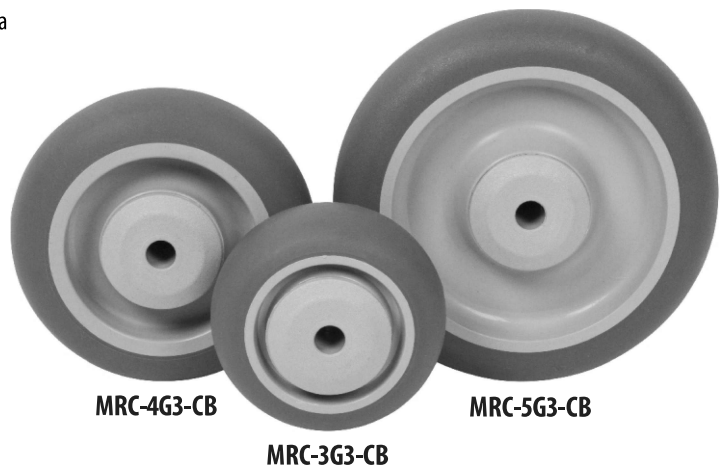

Polyurethane Tread Aluminum Center wheels

PAL Wheels / Capacity up to 1,500 Lbs.



Features

- Polyurethane tread chemically bonded to strong aluminum core
- Resistant to most chemicals, oils, acids, grease and water
- Non-marking and floor protective
- **Bearings:** Delrin, Precision and Roller bearings
- **Durometer:** 92 Shore A (+/-5)
- **Temperature range:** -30° F to +180° F
- **Working Speed:** 2 mph (4Km/h)

Wheel Diameter	Tread Width	Hub Length	Bearing ID	Wheel Bearing	Wheel Number	Load Capacity	For Caster
4	2	2-3/16	1-3/16	(w/o bearing)	PAL-4M0	700	TP6640, TP6740
			3/4	Roller	PAL-4M7		
		2-7/16	1/2	Precision	PAL-4M5-PBB		
			3/4	Delrin	PAL-4M7-DB		
5	2	2-3/16	1-3/16	(w/o bearing)	PAL-5M0	1000	TP6650, TP6750, TP6850
			3/4	Roller	PAL-5M7		
		2-7/16	1/2	Precision	PAL-5M5-PBB		
			3/4	Delrin	PAL-5M7-DB		
6	2	2-3/16	1-3/16	(w/o bearing)	PAL-6M0	1200	TP6660, TP6760, TP6860, TP7060
			3/4	Roller	PAL-6M7		
		2-7/16	1/2	Precision	PAL-6M5-PBB		
			3/4	Delrin	PAL-6M7-DB		
8	2	2-3/16	1-3/16	(w/o bearing)	PAL-8M0	1500	TP6680, TP6780, TP6880, TP7080
			3/4	Roller	PAL-8M7		
		2-7/16	1/2	Precision	PAL-8M5-PBB		
			3/4	Delrin	PAL-8M7-DB		

Note: The load capacity for wheels only may be higher than when used in a caster.

Crowned Polyurethane Tread Aluminum Center wheels

PALC wheels / Capacity up to 1,800 Lbs.

PALC Wheels



Features

- Crown Polyurethane tread is chemically and mechanically bonded to aluminum core
- Non-marking crown tread polyurethane protects floors, helps reduce noise operation
- Resistant to most chemicals, oils, acids, grease and water
- **Bearings:** Precision ball bearing #6203-2RS with Top Hat
- **Durometer:** 85 Shore A (+/-5), available 92 Shore A (+/-5)
- **Temperature range:** -40° F to +180° F
- **Working Speed:** 3 mph (6 Km/h)

Wheel Diameter	Tread Width	Hub Length	Bearing ID	Wheel Bearing	Wheel Number	Load Capacity	For Caster
4	2	2-3/16	1/2	Precision	PALC-4M5-PBB	600	TP6640, TP6640 KPL, TP6740
5	2	2-3/16	1/2	Precision	PALC-5M5-PBB	800	TP6650, TP6650KPL, TP6750, TP6850
6	2	2-3/16	1/2	Precision	PALC-6M5-PBB	1200	TP6660, TP6660KPL, TP7062MF, TP6961SA
8	2	2-3/16	1/2	Precision	PALC-8M5-PBB	1800	TP6680, TP6680KPL, TP7082MF, TP9681SA,

Note: The load capacity for wheels only may be higher than when used in a caster.

Wheel Options



**PALC-6M5-PBB
(RED)**



**PALC-6M5-PBB
(ORANGE)**



**PALC-6M5-PBB
(GREEN)**

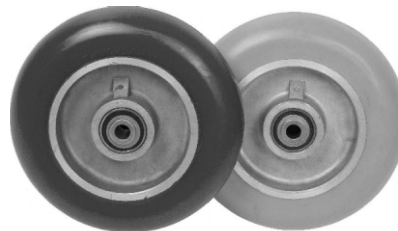

**PALC-8M5-PBB
(RED)**

**PALC-8M5-PBB
(ORANGE)**

Polyurethane Tread Cast Iron Wheels

PCI Wheels / Capacity up to 3,200 Lbs.



Features

- Polyurethane tread chemically bonded to cast iron steel core
- Resistant to most chemicals, oils, acids, grease and water
- Non-marking tread is floor-protective
- **Bearings:** Delrin, ball, precision ball or roller bearings
- **Durometer:** 95 Shore A (±5)
- **Temperature range:** -40° F to +160° F

Wheel Diameter	Tread Width	Hub Length	Bearing ID	Wheel Bearing	Wheel Number	Load Capacity	For Caster
4	1-1/2	1-5/8	1-3/16	(w/o bearing)	PCI-4K0	600	TP6240, TP6440
		1-7/8	3/4	Roller	PCI-4K7	600	
	2	2-3/16	1-3/16	(w/o bearing)	PCI-4M0	800	TP6640, TP6740, TP7040
		2-7/16	3/4	Roller	PCI-4M7	800	
			1/2	Precision	PCI-4M5-PBB	800	
5	1-1/2	1-5/8	1-3/16	(w/o bearing)	PCI-5K0	800	TP6250, TP6450
		1-7/8	3/4	Roller	PCI-5K7	800	
	2	2-3/16	1-3/16	(w/o bearing)	PCI-5M0	1000	TP6650, TP6750, TP6850, TP7050
		2-7/16	3/4	Roller	PCI-5M7	1000	
			1/2	Precision	PCI-5M5-PBB	1000	
6	1-1/2	1-5/8	1-3/16	(w/o bearing)	PCI-6K0	800	TP6260, TP6460
		1-7/8	3/4	Roller	PCI-6K7	800	
	2	2-3/16	1-3/16	(w/o bearing)	PCI-6M0	1200	TP6660, TP6760, TP6860, TP7060
		2-7/16	3/4	Roller	PCI-6M7	1200	
			1/2	Precision	PCI-6M5-PBB	1200	
	2-1/2	2-3/4	1-15/16	(w/o bearing)	PCI-6P0	1600	TP6960, TP7160, TP7260
			1	Roller	PCI-6P8	1600	
	3	3-1/4	1-15/16	(w/o bearing)	PCI-6R0	2000	TP7560, TP7260KPL, TP7560KPL
1			Roller	PCI-6R8	2000		
8	2	2-3/16	1-3/16	(w/o bearing)	PCI-8M0	1400	TP6680, TP6780, TP6880, TP7080
		2-7/16	3/4	Roller	PCI-8M7	1400	
			1/2	Precision	PCI-8M5-PBB	1400	
	2-1/2	2-3/4	1-15/16	(w/o bearing)	PCI-8P0	2000	TP6980, TP7180, TP7280
			1	Roller	PCI-8P8	2000	
	3	3-1/4	1-15/16	(w/o bearing)	PCI-8R0	2500	TP7580, TP7280KPL, TP7500KPL
1			Roller	PCI-8R8	2500		
10	2-1/2	2-3/4	1-15/16	(w/o bearing)	PCI-10P0	2200	TP6910, TP7110, TP7210
			1	Roller	PCI-10P8	2200	
	3	3-1/4	1-15/16	(w/o bearing)	PCI-10R0	3000	TP7510, TP7210KPL, TP7500KPL
			1	Roller	PCI-10R8	3000	
			1-1/4	Roller	PCI-10R9	3000	
12	2-1/2	2-3/4	1-15/16	(w/o bearing)	PCI-12P0	2500	TP6912, TP7112, TP7212
			1	Roller	PCI-12P8	2500	
	3	3-1/4	1-15/16	(w/o bearing)	PCI-12R0	3200	TP7512, TP7212KPL, TP7512KPL
			1	Roller	PCI-12R8	3200	
			1-1/4	Roller	PCI-12R9	3200	

Note: The load capacity for wheels only may be higher than when used in a caster.

Crowned Polyurethane Tread Cast Iron Center wheels

PCC wheels / Capacity up to 1,400 Lbs.



Features

- Crown Polyurethane tread chemically bonded to cast iron steel core
- Non-marking crown tread polyurethane protects floors, helps reduce noise operation
- Resistant to most chemicals, oils, acids, grease and water
- **Bearings:** Delrin, Precision Ball or Roller Bearings
- **Durometer:** 95 Shore A (+/-5)
- **Temperature range:** -40° F to +160° F

PCC Wheels

Wheel Diameter	Tread Width	Hub Length	Bearing ID	Wheel Bearing	Wheel Number	Load Capacity	For Caster
4	2	2-3/16	1-3/16	(w/o bearing)	PCC-4M0	800	TP6640, TP6640KPL
			3/4	Roller	PCC-4M7		
		2-7/16	1/2	Precision	PCC-4M5-PBB		
			1/2	Delrin	PCC-4M5-DB		
			3/4	Delrin	PCC-4M7-DB		
5	2	2-3/16	1-3/16	(w/o bearing)	PCC-5M0	1000	TP6650, TP6650KPL, TP6850
			3/4	Roller	PCC-5M7		
		2-7/16	1/2	Precision	PCC-5M5-PBB		
			1/2	Delrin	PCC-5M5-DB		
			3/4	Delrin	PCC-5M7-DB		
6	2	2-3/16	1-3/16	(w/o bearing)	PCC-6M0	1200	TP6660, TP6660KPL, TP6860, TP7060
			3/4	Roller	PCC-6M7		
		2-7/16	1/2	Precision	PCC-6M5-PBB		
			1/2	Delrin	PCC-6M5-DB		
			3/4	Delrin	PCC-6M7-DB		
8	2	2-3/16	1-3/16	(w/o bearing)	PCC-8M0	1400	TP6680, TP6680KPL, TP6880, TP7080
			3/4	Roller	PCC-8M7		
		2-7/16	1/2	Precision	PCC-8M5-PBB		
			1/2	Delrin	PCC-8M5-DB		
			3/4	Delrin	PCC-8M7-DB		

PCC wheels for Shock Absorbing Casters

Wheel Diameter	Tread Width	Hub Length	Bearing ID	Wheel Bearing	Wheel Number	Load Capacity	For Caster
6	2	2-7/16	1/2	Precision	PCC-6M5-PBB-SA	1200	TP6865MFS, TP9660SA, TP9661SA
8	2			Precision	PCC-8M5-PBB-SA	1400	TP9680SA, TP9681SA

* Precision Ball Bearing : #6203ZZ with Spanner Bushing or Top Hat

Polyurethane Tread Nylon Center Wheels

PNY Wheels / Capacity up to 1,400 Lbs.



Features

- Polyurethane tread specially bonded to a high-impact glass-filled nylon core
- Floor protective, non-marking and helps absorb shocks
- Nylon Core is strong like steel, without the density and weight
- Costs less to ship than cast iron cores, and doesn't rust
- Resistant to most chemicals, oils, acids, grease and water
- **Bearings:** Delrin, ball, precision ball or roller bearings
- **Durometer:** 95 Shore A (±5)
- **Temperature range:** -40° F to +180° F

Wheel Diameter	Tread Width	Hub Length	Bearing ID	Wheel Bearing	Wheel Number	Load Capacity	For Caster
4	2	2-3/16	1-3/16	(w/o bearing)	PNY-4M0	700	TP6640, TP6740, TP6840, TP7040
			3/4	Roller	PNY-4M7		
		2-7/16	1/2	Precision	PNY-4M5-PBB		
			1/2	Delrin	PNY-4M5-DB		
			3/4	Delrin	PNY-4M7-DB		
5	2	2-3/16	1-3/16	(w/o bearing)	PNY-5M0	1000	TP6650, TP6750, TP6850, TP7050
			3/4	Roller	PNY-5M7		
		2-7/16	1/2	Precision	PNY-5M5-PBB		
			1/2	Delrin	PNY-5M5-DB		
			3/4	Delrin	PNY-5M7-DB		
6	2	2-3/16	1-3/16	(w/o bearing)	PNY-6M0	1200	TP6660, TP6760, TP6860, TP7060
			3/4	Roller	PNY-6M7		
		2-7/16	1/2	Precision	PNY-6M5-PBB		
			1/2	Delrin	PNY-6M5-DB		
			3/4	Delrin	PNY-6M7-DB		
8	2	2-3/16	1-3/16	(w/o bearing)	PNY-8M0	1400	TP6680, TP6780, TP6880, TP7080
			3/4	Roller	PNY-8M7		
		2-7/16	1/2	Precision	PNY-8M5-PBB		
			1/2	Delrin	PNY-8M5-DB		
			3/4	Delrin	PNY-8M7-DB		

Note: The load capacity for wheels only may be higher than when used in a caster.

Solid Polyurethane Wheels

PLX Wheels / Capacity up to 1000 Lbs.



Features

- Perfectly molded and machined for high performance
- No tread separation, rusting, water absorption or floor-marking
- Resistant to most chemicals, oils, acids, greases and other icky stuff
- Excellent for wash-down situations or applications in or around a lot of water
- **Bearings:** Delrin, roller or precision ball bearings
- **Durometer:** 60 Shore D (±5)
- **Temperature range:** -40° F to + 180° F

PLX Wheels

Wheel Diameter	Tread Width	Hub Length	Bearing ID	Wheel Bearing	Wheel Number	Load Capacity	For Caster	
3	1-17/64	1-9/16	1/2	Plain	PLX-3H5-PB	300	TP5030,TP5130,TP5230,TP5330	
4	1-1/2	1-9/16	1/2	Plain	PLX-4H5-PB	400	TP5040,TP5140,TP5240,TP5340	
		1-5/8	1-3/16	(w/o bearing)	PLX-4K0			
		1-7/8	3/4	Roller	PLX-4K7			
	2	2-3/16	1-3/16	3/4	Delrin	PLX-4K7-DB	750	TP6240, TP6440
			1-3/16	(w/o bearing)	PLX-4M0			
			3/4	Roller	PLX-4M7			
5	1-1/2	2-7/16	1/2	Precision	PLX-4M5-PBB	750	TP6640, TP6740, TP6840, TP7040	
		3/4	Delrin	PLX-4M7-DB				
		1-9/16	1/2	Plain	PLX-5H5-PB			700
	1-5/8	1-3/16	(w/o bearing)	PLX-5K0				
	1-7/8	3/4	Roller	PLX-5K7				
	2	2-3/16	3/4	Delrin	PLX-5K7-DB	800	TP6250, TP6450	
1-3/16			(w/o bearing)	PLX-5M0				
3/4			Roller	PLX-5M7				
6	2	2-7/16	1/2	Precision	PLX-5M5-PBB	900	TP6650, TP6750, TP6850	
			3/4	Delrin	PLX-5M7-DB			
			1-3/16	(w/o bearing)	PLX-6M0			
			3/4	Roller	PLX-6M7			
8	2	2-7/16	1/2	Precision	PLX-6M5-PBB	1000	TP6660, TP6760, TP6860, TP7060	
			3/4	Delrin	PLX-6M7-DB			
			1-3/16	(w/o bearing)	PLX-8M0			
			3/4	Roller	PLX-8M7			
2	2-3/16	1-3/16	3/4	Delrin	PLX-8M5-PBB	1000	TP6680, TP6780, TP6880, TP7080	
		1-3/16	(w/o bearing)	PLX-8M0				
		3/4	Roller	PLX-8M7				

Note: The load capacity for wheels only may be higher than when used in a caster.

Polyurethane Tread Plastic Center Wheels

PLY Wheels / Capacity up to 300 Lbs.



Features

- Polyurethane tread mechanically bonded to polypropylene core
- Resistant to most chemicals, oils, acids, grease and water
- Soft cushion ride like rubber, but non-marking and floor protective
- **Bearings:** Plain, ball or precision bearings
- **Durometer:** 95 Shore A (±5)
- **Temperature range:** -30° F to 180° F

Wheel Diameter	Tread Width	Hub Length	Bearing ID	Wheel Bearing	Wheel Number	Load Capacity	For Caster
2	13/16	7/8	15/64	Plain	PLY-2A1	80	TP3020
	15/16	1	1/4	Plain	PLY-2B1	90	TP3220, TP4020
2-1/2	1-1/18	1-3/8	5/16	Plain	PLY-25F2	175	TP4025
3	13/16	7/8	15/64	Plain	PLY-3A1	100	TP3030
		1-9/16	3/8	Plain	PLY-3H3-PB	250	TP4030, TP5030, TP5130, TP5230, TP5330, TP5430
	1-1/4	1-5/8	3/8	Ball	PLY-3J3	250	
		3/8	Precision	PLY-3J3-CB-P/TG			
3-1/2	1-1/4	1-7/16	3/8	Precision	PLY-35J3-CB-P/TG	250	TP5035, TP5235
4	1-1/4	1-9/16	3/8	Plain	PLY-4H3-PB	280	TP5040, TP5140, TP5240, TP5340, TP5440
			5/16	Ball	PLY-4J2		
		1-5/8	3/8	Ball	PLY-4J3	280	TP5040, TP5240, TP5440
			3/8	Precision	PLY-4J3-CB		
			3/8	Precision	PLY-4J3-CB-F/TG		
5	1-1/4	1-9/16	3/8	Plain	PLY-5H3-PB	300	TP5050, TP5150, TP5250, TP5350, TP5450
			5/16	Ball	PLY-5J2		
		1-5/8	5/16	Precision	PLY-5J2-CB	300	TP8150
			3/8	Ball	PLY-5J3		
			3/8	Precision	PLY-5J3-CB		
			3/8	Precision	PLY-5J3-CB-F/TG		

Note: The load capacity for wheels only may be higher than when used in a caster.



PLY-5J3
(DARK BLUE)



PLY-5J3-CB
(RED)



PLY-5J3-CB-F/TG
(MAROON)



PLY-5J3-CB-F/TG
(DARK BLUE)

Pro-Tech Polyurethane Wheels

PRO Wheels / Capacity up to 1,000 Lbs.

PRO Wheels



Features

- Polyurethane tread mechanically bonded to polypropylene core
- Resistant to most chemicals, oils, acids, grease and water
- Non-marking tread is floor-protective
- **Bearings:** Delrin, roller or precision ball bearings
- **Durometer:** 95 Shore A (±5)
- **Temperature range:** -30° F to 180° F

Wheel Diameter	Tread Width	Hub Length	Bearing ID	Wheel Bearing	Wheel Number	Load Capacity	For Caster
4	1-1/2	1-5/8	1-3/16	(w/o bearing)	PRO-4K0	500	TP6240, TP6440
		1-7/8	3/4	Roller	PRO-4K7		
		1-7/8	3/4	Delrin	PRO-4K7-DB		
		1-5/8	1-3/16	Roller	PRO-4K5		
	2	2-3/16	1-3/16	(w/o bearing)	PRO-4M0	700	TP5040, TP5140, TP5240
				Roller	PRO-4M7		
		2-7/16	1/2	Precision	PRO-4M5-PBB		
			3/4	Delrin	PRO-4M7-DB		
5	1-1/2	1-5/8	1-3/16	(w/o bearing)	PRO-5K0	600	TP6250, TP6450
		1-7/8	3/4	Roller	PRO-5K7		
		1-7/8	3/4	Delrin	PRO-5K7-DB		
		1-5/8	1-3/16	Roller	PRO-5K5		
	2	2-3/16	1-3/16	(w/o bearing)	PRO-5M0	750	TP5050, TP5150, TP5250
				Roller	PRO-5M7		
		2-7/16	1/2	Precision	PRO-5M5-PBB		
			3/4	Delrin	PRO-5M7-DB		
6	1-1/2	1-5/8	1-3/16	(w/o bearing)	PRO-6K0	700	TP6260, TP6460
		1-7/8	3/4	Roller	PRO-6K7		
		1-7/8	3/4	Delrin	PRO-6K7-DB		
	2	2-3/16	1-3/16	(w/o bearing)	PRO-6M0	900	TP6660, TP6860, TP7060
				Roller	PRO-6M7		
		2-7/16	1/2	Precision	PRO-6M5-PBB		
			3/4	Delrin	PRO-6M7-DB		
8	2	2-3/16	1-3/16	(w/o bearing)	PRO-8M0	1000	TP6680, TP6880, TP7080
			Roller	PRO-8M7			
		2-7/16	1/2	Precision	PRO-8M5-PBB		
			3/4	Delrin	PRO-8M7-DB		

Note: The load capacity for wheels only may be higher than when used in a caster.



Red



Maroon



Blue Green

Hi-Elastic Polyurethane Plastic Center Wheels

PLE Wheels / Capacity up to 175 Lbs.

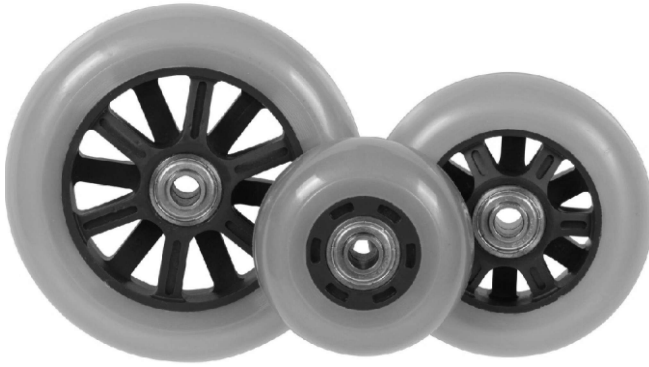

Features

- Hi-elastic polyurethane tread mechanically bonded to polypropylene core
- Resistant to most chemicals, oils, acids, grease and water
- Soft cushion ride like rubber, but non-marking & floor protective
- Crown tread for extra-easy maneuverability
- **Bearing:** Precision bearings
- **Durometer:** 80 Shore A (±5)
- **Temperature range:** -40° F to 160° F

Wheel Diameter	Tread Width	Hub Length	Bearing ID	Wheel Bearing	Wheel Number	Load Capacity	For Caster
3	1-1/4	1-9/16	3/8	Precision	PLE-3H3	125	TP4030, TP5030, TP5130, TP5230
4					PLE-4H3	165	TP5040, TP5140, TP5240, TP5340
5					PLE-5H3	175	TP5050, TP5150, TP5250, TP5350

Note: The load capacity for wheels only may be higher than when used in a caster.

Pro-Tech Extra Performance Wheels

PRX Wheels / Capacity up to 1200 Lbs.



Features

- High Quality Polyurethane tread
- High Impact Polypropylene core
- Tread mechanically locked to core
- Resistant to most chemicals, oils, acids, grease and water
- Non-marking tread is floor-protective
- Maintenance-free -- no need to lubricate the bearings
- **Bearing:** Precision bearings (#6301RS)
- **Durometer:** 95 Shore A (±5)
- **Temperature range:** -30° F to + 180° F

Wheel Diameter	Tread Width	Hub Length	Bearing ID	Wheel Bearing	Wheel Number	Load Capacity	For Caster
4	2	2-7/16	1/2	Precision Ball (#6301-2RS)	PRX-4M5	600	TP6640, TP6740
5					PRX-5M5	800	TP6650, TP6750, TP6850
6					PRX-6M5	1000	TP6660, TP6760, TP6860, TP7060
8					PRX-8M5	1200	TP6680, TP6780, TP6880, TP7080

Note: The load capacity for wheels only may be higher than when used in a caster.

Phenolic Wheels

PHN Wheels / Capacity up to 3,500 Lbs.

PHN Wheels



Features

- Macerated construction with cellulose fibers and impregnated with phenolic resin
- Excellent durability, non-marking and floor protective
- Resists water, grease, animal fats and most acids and alkalis
- **Bearings:** Plain bore, delrin, precision ball or roller bearings
- **Durometer:** 90 Shore D (±5)
- **Temperature range:** -50° F to +250° F

Wheel Diameter	Tread Width	Hub Length	Bearing ID	Wheel Bearing	Wheel Number	Load Capacity	For Caster	
3	1-1/4	1-9/16	3/8	Plain	PHN-3H3	300	TP5030, TP5130, TP5230, TP5430	
	1-13/16	2	1-3/16	(w/o bearing)	PHN-3L0	600	TP8030	
			5/8	Roller	PHN-3L6			
4	1-1/2	1-5/8	1/2	Plain	PHN-4H5-PB	350	TP5040, TP5140, TP5240, TP5340	
				Roller	PHN-4K5			
			1-3/16	(w/o bearing)	PHN-4K0	600	TP6240, TP6440	
	1-7/8	3/4	Roller	PHN-4K7				
	2	2-7/16	2-3/16	1-3/16	(w/o bearing)	PHN-4M0	800	TP6640, TP6740
			3/4	Roller	PHN-4M7			
5	1-1/2	1-5/8	1/2	Plain	PHN-5H5-PB	450	TP5050, TP5150, TP5250, TP5350	
				Roller	PHN-5K5			
			1-3/16	(w/o bearing)	PHN-5K0	700	TP6250, TP6450	
	1-7/8	3/4	Roller	PHN-5K7				
	2	2-7/16	2-3/16	1-3/16	(w/o bearing)	PHN-5M0	1000	TP6650, TP6750, TP6850
			3/4	Roller	PHN-5M7			
6	1-1/2	1-5/8	1-3/16	(w/o bearing)	PHN-6K0	800	TP6260, TP6460	
			3/4	Roller	PHN-6K7			
	2	2-7/16	2-3/16	1-3/16	(w/o bearing)	PHN-6M0	1200	TP6660, TP6760, TP6860, TP7060
			3/4	Roller	PHN-6M7			
	2-1/2	2-3/4	1-15/16	(w/o bearing)	PHN-6P0	1600	TP6960, TP7160, TP7260	
			1	Roller	PHN-6P8			
	3	3-1/4	1-15/16	(w/o bearing)	PHN-6R0	2000	TP7560, TP7260KPL, TP7560KPL	
			1	Roller	PHN-6R8			
8	2	2-3/16	1-3/16	(w/o bearing)	PHN-8M0	1400	TP6680, TP6780, TP6880, TP7080	
		2-7/16	3/4	Roller	PHN-8M7			
	2-1/2	2-3/4	1-15/16	(w/o bearing)	PHN-8P0	2000	TP6980, TP7180, TP7280	
			1	Roller	PHN-8P8			
	3	3-1/4	1-15/16	(w/o bearing)	PHN-8R0	2500	TP7580, TP7280KPL, TP7580KPL	
			1	Roller	PHN-8R8			
10	2-1/2	2-3/4	1-15/16	(w/o bearing)	PHN-10P0	2500	TP7110, TP7210	
			1	Roller	PHN-10P8			
	3	3-1/4	1-15/16	(w/o bearing)	PHN-10R0	2800	TP7510, TP7210KPL, TP7510KPL	
			1	Roller	PHN-10R8			
12	2-1/2	2-3/4	1-15/16	(w/o bearing)	PHN-12P0	3000	TP7112, TP7212	
			1	Roller	PHN-12P8			
	3	3-1/4	1-15/16	(w/o bearing)	PHN-12R0	3500	TP7512, TP7212KPL, TP7512KPL	
			1	Roller	PHN-12R8			

Note: The load capacity for wheels only may be higher than when used in a caster.

Phenolic Hi-Temperature Wheels

PHN Wheels / Capacity up to 2,500 Lbs.



Features

- Macerated construction with cellulose fibers and impregnated with phenolic resin
- Excellent durability, non-marking and floor protective
- Resists water, grease, animal fats and most acids and alkalis
- **Bearings:** Plain bore, precision ball or roller bearings
- **Durometer:** 95 Shore D (±5)
- **Temperature range:** -40° F to + 475° F continuous, 550° F intermittent

Wheel Diameter	Tread Width	Hub Length	Bearing ID	Wheel Bearing	Wheel Number	Load Capacity	For Caster	
4	1-1/2	1-5/8	1/2	Plain	PHN-4H5-HT	350	TP5040, TP5140, TP5240, TP5340	
			1-3/16	(w/o bearing)	PHN-4K0-HT	600	TP6240, TP6440	
			1/2	Roller	PHN-4K5-HT			
	2	2-3/16	1-3/16	1-7/8	Roller	PHN-4K7-HT	800	TP6640, TP6740
				3/4	(w/o bearing)	PHN-4M0-HT		
				3/4	Roller	PHN-4M7-HT		
5	1-1/2	1-5/8	1/2	Plain	PHN-5H5-HT	350	TP5050, TP5150, TP5250, TP5350	
			1-3/16	(w/o bearing)	PHN-5K0-HT	700	TP6250, TP6450	
			1-7/8	Roller	PHN-5K7-HT			
	2	2-3/16	1-3/16	2-7/16	(w/o bearing)	PHN-5M0-HT	1000	TP6650, TP6750, TP6850
				3/4	Roller	PHN-5M7-HT		
6	1-1/2	1-5/8	1-3/16	(w/o bearing)	PHN-6K0-HT	800	TP6260, TP6460	
			3/4	Roller	PHN-6K7-HT			
	2	2-3/16	1-3/16	2-7/16	(w/o bearing)	PHN-6M0-HT	1200	TP6660, TP6760, TP6860, TP7060
				3/4	Roller	PHN-6M7-HT		
	2-1/2	2-3/4	1-15/16	1	(w/o bearing)	PHN-6P0-HT	1600	TP6960, TP7160, TP7260
				1	Roller	PHN-6P8-HT		
	3	3-1/4	1-15/16	1	(w/o bearing)	PHN-6R0-HT	2000	TP7560, TP7260KPL, TP7560KPL
				1	Roller	PHN-6R8-HT		
8	2	2-3/16	1-3/16	(w/o bearing)	PHN-8M0-HT	1400	TP6680, TP6780, TP6880, TP7080	
			3/4	Roller	PHN-8M7-HT			
	2-1/2	2-3/4	1-15/16	1	(w/o bearing)	PHN-8P0-HT	2000	TP6980, TP7180, TP7280
				1	Roller	PHN-8P8-HT		
	3	3-1/4	1-15/16	1	(w/o bearing)	PHN-8R0-HT	2500	TP7580, TP7280KPL, TP7580KPL
				1	Roller	PHN-8R8-HT		

Note: The load capacity for wheels only may be higher than when used in a caster.

Fever Hi-Temperature Wheels

FVR Wheels / Capacity up to 1,400 Lbs.



Features

- Specially formulated nylon/glass wheel designed to take higher temperatures
- Highly resistant to water, cooking oils, fats, petroleum-based products, cleaning solutions, solvents and most acids
- **Bearings:** Plain bore or roller bearings
- **Durometer:** 85 Shore D (±5)
- **Temperature range:** -40° F to +475° F continuously, 525° F intermittently

Wheel Diameter	Tread Width	Hub Length	Bearing ID	Wheel Bearing	Wheel Number	Load Capacity	For Caster	
4	1-1/4	1-23/64	1/2	Plain	FVR-4H5-PB	350	TP5040, TP5140, TP5240, TP5340	
			1/2	Plain	FVR-4K5-PB			
	1-1/2	1-37/64	1-3/16	(w/o bearing)	FVR-4K0	600	TP6240, TP6440	
			3/4	Roller	FVR-4K7			
2	2-3/16	2-7/16	1-3/16	(w/o bearing)	FVR-4M0	800	TP6640, TP6740,	
			3/4	Roller	FVR-4M7			
5	1-1/4	1-23/64	1/2	Plain	FVR-5H5-PB	450	TP5050, TP5150, TP5250, TP5350	
			1/2	Plain	FVR-5K5-PB			
	1-1/2	1-37/64	1-3/16	(w/o bearing)	FVR-5K0	700	TP6250, TP6450	
			3/4	Roller	FVR-5K7			
2	2-3/16	2-7/16	1-3/16	(w/o bearing)	FVR-5M0	1000	TP6650, TP6750, TP6850	
			3/4	Roller	FVR-5M7			
6	1-1/2	1-37/64	1-3/16	(w/o bearing)	FVR-6K0	900	TP6260, TP6460	
			3/4	Roller	FVR-6K7			
	2	2-3/16	2-7/16	1-3/16	(w/o bearing)	FVR-6M0	1200	TP6660, TP6760, TP6860, TP7060
				3/4	Roller	FVR-6M7		
8	2	2-3/16	1-3/16	(w/o bearing)	FVR-8M0	1400	TP6680, TP6780, TP6880, TP7080	
			2-7/16	3/4	Roller			FVR-8M7

Note: The load capacity for wheels only may be higher than when used in a caster.

Fever-Tech Hi-Temperature Wheels

FVT Wheels / Capacity up to 700 Lbs.



Features

- Compression-molded high-temperature epoxy resin thermoset material
- Easy-rolling integrated ball bearing locked in hub
- High temp grease injected in bearing -- no maintenance required
- Superior high-temp performance, unmatched by phenolic or fiberglass
- **Durometer:** 95 Shore D (±5)
- **Temperature range:** -40° F to +475° F continuously, 525° F intermittent

Wheel Diameter	Tread Width	Hub Length	Bearing ID	Wheel Bearing	Wheel Number	Load Capacity	For Caster
4	1-1/2	1-5/8	3/8	Precision	FVT-4K3	700	TP5040, TP5140, TP5240, TP5340

Note: The load capacity for wheels only may be higher than when used in a caster.

Pneumatic wheels

PNU Wheels / Capacity up to 500 Lbs.



Features

- 50 PSI Maximum inflation on 10" wheels
- 50 PSI Maximum inflation on 8" wheels
- 4-Ply Nylon Saw-tooth tread tires
- 17% Natural rubber inner tubes with brass air nipple
- 3-Piece zinc plated steel hubs with zerk grease fitting
- Buna rubber sealed precision ball bearings
- 8" wheel with 2.80 / 2.5 – 4 Tire / 350 # Capacity
- 10" wheel with 4.10 / 3.5 – 4Tire / 500 # Capacity
- Available in both centered hub (for casters) and off-set hubs (for hand trucks)

Wheel Diameter	Tread Width	Hub Length	Hub Type	Ply Rating	Bearing ID	Wheel Bearing	Wheel Number	Load Capacity	PSI
8	2-1/2	3-1/2" centered	3 PCS	4	1-3/8	W/O Bearing	PNU-8P0-PBB-C	350	50
					1/2	Precision	PNU-8P5-PBB-C		
					5/8		PNU-8P6-PBB-C		
					3/4	PNU-8P7-PBB-C			
		2-1/4" off-set	3 PCS	4	1-3/8	W/O Bearing	PNU-8P0-PBB-O		
					1/2	Precision	PNU-8P5-PBB-O		
					5/8		PNU-8P6-PBB-O		
					3/4	PNU-8P7-PBB-O			
10	3-1/2	4" centered	3 PCS	4	1-3/8	W/O Bearing	PNU-10R0-PBB-C	500	50
					1/2	Precision	PNU-10R5-PBB-C		
					5/8		PNU-10R6-PBB-C		
					3/4	PNU-10R7-PBB-C			
		2-1/4" off-set	3 PCS	4	1-3/8	W/O Bearing	PNU-10R0-PBB-O		
					1/2	Precision	PNU-10R5-PBB-O		
					5/8		PNU-10R6-PBB-O		
					3/4	PNU-10R7-PBB-O			

Note: The load capacity for wheels only may be higher than when used in a caster.

Options		
DESCRIPTION	SIZE	PARTNUMBER AND CODE
INNER TUB	8"	ITB-080
	10"	ITB-010
TIRE ONLY	8"	T4P-080 4PLY TIRE ONLY
	10"	T4P-010 4PLY TIRE ONLY
PRECISION BEARING		PBB
BALL BEARING		BB

Add Option Code to end of part number.



PNU-10R5-PBB-C
(Centered Hub)



PNU-10R5-PBB-O
(Off-Set Hub)

Air / Flat Free Wheels

AFR / Flat Free Wheels / Capacity up to 300 Lbs.

AFR Wheels



Features

- Solid polyurethane tire with Saw-tooth tread
- Good durability with excellent floor protection
- Light weight, non-marking and flat-free
- 8" wheel with 2.80 / 2.5 – 4 Tire / 275 # Capacity
- 10" wheel with 4.10 / 3.5 – 4Tire / 300 # Capacity
- Available in both centered hub (for casters) and off-set hubs (for hand trucks)
- One piece gray hub with zerk grease fitting
- Sealed precision bearing

Wheel Diameter	Tread Width	Hub Length	Hub Type	Bearing ID.	Wheel Bearing	Wheel Number	Load Capacity	Ply Rating		
6	2	2-3/8	1 PCS	1/2	Precision	AFR-6M5-PBB-C	250	Sawtooth Tire Gray Steel Rim		
8						AFR-8M5-PBB-C	275			
8	2-1/2	3-1/2" centered	1 PCS	1-3/8	W/O Bearing	AFR-8P0-PBB-C	275	2.80/2.5 - 4 PU JAG Tire on 4 x 3-1/2 Gray Steel Rim		
				1/2	Precision	AFR-8P5-PBB-C				
				5/8		AFR-8P6-PBB-C				
		3/4	W/O Bearing	AFR-8P7-PBB-C						
		2-1/4" off-set		1 PCS	1-3/8	W/O Bearing			AFR-8P0-PBB-O	2.80/2.5 - 4 PU JAG Tire on 4 x 2-1/4 Gray Steel Rim
					1/2	Precision			AFR-8P5-PBB-O	
5/8	AFR-8P6-PBB-O									
3/4	AFR-8P7-PBB-O									
10	3-1/2	4" centered	1 PCS	1-3/8	W/O Bearing	AFR-10R0-PBB-C	300	4.10/3.5 - 4 PU Sawtooth Tire on 4 x 4 Gray Steel Rim		
				1/2	Precision	AFR-10R5-PBB-C				
				5/8		AFR-10R6-PBB-C				
		3/4	W/O Bearing	AFR-10R7-PBB-C						
		2-1/4" off-set		1 PCS	1-3/8	W/O Bearing			AFR-10R0-PBB-O	4.10/3.5 - 4 PU Sawtooth Tire on 4 x 2-1/4 Gray Steel Rim
					1/2	Precision			AFR-10R5-PBB-O	
5/8	AFR-10R6-PBB-O									
3/4	AFR-10R7-PBB-O									

Note: The load capacity for wheels only may be higher than when used in a caster.

Options	
DESCRIPTION	CODE
PRECISION BEARING	PBB
BALL BEARING	BB

Add Option Code to end of part number.



AFR-6M5-PBB-C



AFR-10R7-PBB-C
(Centered Hub)



AFR-10R6-PBB-O
(Off-Set Hub)

Semi-Pneumatic Wheels

ZERO Wheels / Capacity up to 850 Lbs.



Features

- Solid rubber tire on polypropylene core
- Puncture-proof - won't go flat
- Quiet, resilient, with great life expectancy
- Available in both centered hub (for casters) and off-set hubs (for hand trucks)
- **Temperature ranges:** -20° F to +140° F

Wheel Diameter	Tread Width	Hub Length	Bearing ID Size	Wheel Bearing	Wheel Number	Load Capacity	Note							
6	1-3/4	1-3/4	1/2	Ball	ZRB-6K5-C	350	Centered Hub							
			5/8		ZRB-6K6-C									
			3/4		ZRB-6K7-C									
	1-1/2	2-1/4	1/2	Roller	ZRR-6K5-C									
			5/8		ZRR-6K6-C									
			3/4		ZRR-6K7-C									
	1-3/4	2-1/4	1/2	Ball	ZRB-6L5-C									
			5/8		ZRB-6L6-C									
			3/4		ZRB-6L7-C									
			1/2	Roller	ZRR-6L5-C									
			5/8		ZRR-6L6-C									
			3/4		ZRR-6L7-C									
8	2	2-1/4	1/2	Ball	ZRB-8M5-C	440	Centered Hub							
			5/8		ZRB-8M6-C									
			3/4		ZRB-8M7-C									
			1/2	Roller	ZRR-8M5-C									
			5/8		ZRR-8M6-C									
			3/4		ZRR-8M7-C									
	2-1/2	2-1/4	1/2	Ball	ZRB-8P5-C	450								
			5/8		ZRB-8P6-C									
			3/4		ZRB-8P7-C									
			1/2	Roller	ZRR-8P5-C									
			5/8		ZRR-8P6-C									
			3/4		ZRR-8P7-C									
10	2	2-1/4	1/2	Ball	ZRB-10P5-C	500	Centered Hub							
			5/8		ZRB-10P6-C									
			3/4		ZRB-10P7-C									
	2-3/4	2-1/4	1/2		Ball	ZRB-10Q5-C		550						
			5/8			ZRB-10Q6-C								
			3/4			ZRB-10Q7-C								
		3-1/4	1/2			ZRB-10R5-C								
			5/8			ZRB-10R6-C								
			3/4			ZRB-10R7-C								
			12			2-3/4			3-1/4	1/2	Ball	ZRB-12R5-C	850	Centered Hub
										5/8		ZRB-12R6-C		
										3/4		ZRB-12R7-C		

Note: The load capacity for wheels only may be higher than when used in a caster.

Rubber / Aluminum Center Wheels

RAL Wheels / Capacity up to 800 Lbs.

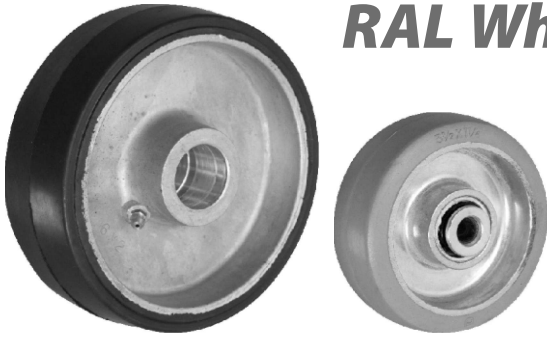

Features

- Soft rubber tread chemically bonded to a strong aluminum core
- Non-marking and floor protective
- Annular bearings on smaller diameters
- Zerk fitting in hub (on 6 & 8" wheels) for lubrication of bearing
- **Durometer:** 75 Shore A (±5)
- **Temperature range:** -20° F to 160° F



Wheel Diameter	Tread Width	Hub Length	Bearing ID	Wheel Bearing	Wheel Number	Load Capacity	For Caster
3-1/2	1-1/4	1-1/2	3/8	Annular	RAL-35G3	225	TP5035, TP5235
4	1-1/4	1-1/2	3/8	Annular	RAL-4G3	250	TP5040, TP5240
5	1-1/4	1-1/2	3/8	Annular	RAL-5G3	275	TP5050, TP5250
6	2	2-3/16	1-3/16	(w/o bearing)	RAL-6M0	550	TP6660, TP6860, TP7060
		2-7/16	3/4	Roller	RAL-6M7		
8	2	2-3/16	1-3/16	(w/o bearing)	RAL-8M0	800	TP6680, TP6880, TP7080
		2-7/16	3/4	Roller	RAL-8M7		

Note: The load capacity for wheels only may be higher than when used in a caster.

Rubber Balloon Cushion Wheels

RND Wheels / Capacity up to 500 Lbs.

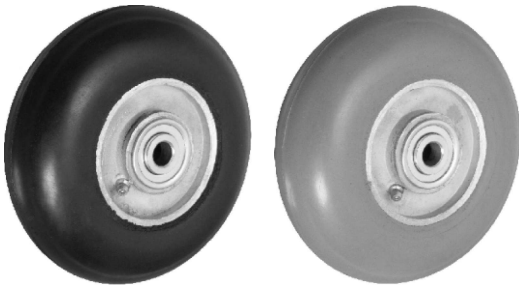

Features

- Soft hi-modulus rubber tread chemically bonded to a strong aluminum core
- Ball bearings standard, roller optional
- Optional gray hubber is non-marking
- **Durometer:** 75 Shore A (±5)
- **Temperature range:** -20° F to 160° F

Wheel Diameter	Tread Width	Hub Length	Bearing ID	Wheel Bearing	Wheel Number	Load Capacity	For Caster
6	2	2-3/16	(less ball bearing)	1-3/8	RND-6M00	410	TP6660, TP6860, TP7060
			(less roller bearing)	1-3/16	RND-6M0		
		2-7/16	Ball	1/2	RND-6M5-BB		
			Ball	5/8	RND-6M6-BB		
			Ball	3/4	RND-6M7-BB		
			Precision	1/2	RND-6M5-PBB		
Roller	3/4	RND-6M7-RB					
8	2	2-3/16	(less ball bearing)	1-3/8	RND-8M00	500	TP6680, TP6880, TP7080
			(less roller bearing)	1-3/16	RND-8M0		
		2-7/16	Ball	1/2	RND-8M5-BB		
			Ball	5/8	RND-8M6-BB		
			Ball	3/4	RND-8M7-BB		
			Precision	1/2	RND-8M5-PBB		
Roller	3/4	RND-8M7-RB					

Note: The load capacity for wheels only may be higher than when used in a caster.

Rubber Tread Cast Iron Center Wheels

RCI Wheels / Capacity up to 1,500 Lbs.



Features

- Soft rubber tread chemically bonded to a strong cast iron core
- Multiple diameters and widths for many different applications
- Roller bearings for strength and ease of maneuverability
- Floor protective
- Zerk fitting in hub for lubrication of bearing
- **Bearings:** Delrin, ball, precision ball or roller bearings
- **Durometer:** 75 Shore A (±5)
- **Temperature range:** -40° F to + 180° F

Wheel Diameter	Tread Width	Hub Length	Wheel Bearing	Bearing ID	Wheel Number	Load Capacity	For Caster
4	1-1/2	1-5/8	(w/o bearing)	1-3/16	RCI-4K0	250	TP6240, TP6440
		1-7/8	Roller	3/4	RCI-4K7		
	2	2-3/16	(w/o bearing)	1-3/16	RCI-4M0	400	TP6640, TP6840, TP7040
		2-7/16	Roller	3/4	RCI-4M7		
5	1-1/2	1-5/8	(w/o bearing)	1-3/16	RCI-5K0	350	TP6250, TP6450
		1-7/8	Roller	3/4	RCI-5K7		
	2	2-3/16	(w/o bearing)	1-3/16	RCI-5M0	450	TP6650, TP6850, TP7050
		2-7/16	Roller	3/4	RCI-5M7		
6	1-1/2	1-5/8	(w/o bearing)	1-3/16	RCI-6K0	450	TP6260, TP6460
		1-7/8	Roller	3/4	RCI-6K7		
	2	2-3/16	(w/o bearing)	1-3/16	RCI-6M0	550	TP6660, TP6860, TP7060
		2-7/16	Roller	3/4	RCI-6M7		
	2-1/2	2-3/4	(w/o bearing)	1-15/16	RCI-6P0	700	TP6960, TP7160, TP7260
		2-3/4	Roller	1	RCI-6P8		
	3	3-1/4	(w/o bearing)	1-15/16	RCI-6R0	750	TP7560
		3-1/4	Roller	1	RCI-6R8		
8	2	2-3/16	(w/o bearing)	1-3/16	RCI-8M0	600	TP6680, TP6880, TP7080
		2-7/16	Roller	3/4	RCI-8M7		
	2-1/2	2-3/4	(w/o bearing)	1-15/16	RCI-8P0	850	TP6980, TP7180, TP7280
		2-3/4	Roller	1	RCI-8P8		
	3	3-1/4	(w/o bearing)	1-15/16	RCI-8R0	900	TP7580
		3-1/4	Roller	1	RCI-8R8		
10	2-1/2	2-3/4	(w/o bearing)	1-15/16	RCI-10P0	950	TP6910, TP7110, TP7210
		2-3/4	Roller	1	RCI-10P8		
	3	3-1/4	(w/o bearing)	1-15/16	RCI-10R0	1000	TP7510
		3-1/4	Roller	1	RCI-10R8		
12	2-1/2	2-3/4	(w/o bearing)	1-15/16	RCI-12P0	950	TP6912, TP7112, TP7212
		2-3/4	Roller	1	RCI-12P8		
	3	3-1/4	(w/o bearing)	1-15/16	RCI-12R0	1200	TP7512
		3-1/4	Roller	1	RCI-12R8		
16	3	3-1/4	(w/o bearing)	1-15/16	RCI-16R0	1500	
		3-1/4	Roller	1	RCI-16R8		

Note: The load capacity for wheels only may be higher than when used in a caster.

Rubber Tread Nylon Center Wheels

RNY Wheels / Capacity up to 600 Lbs.

RNY Wheels



Features

- Thermoplastic rubber tread specially bonded to a high-impact glass-filled nylon core
- Floor protective and helps absorb shocks
- Costs less to ship and doesn't rust
- Similar load capacity to RCI wheel
- **Bearings:** Delrin, ball, precision ball or roller bearings
- **Durometer:** 80 Shore A (±5)
- **Temperature range:** -40° F to +180° F

Wheel Diameter	Tread Width	Hub Length	Wheel Bearing	Bearing ID	Wheel Number	Load Capacity	For Caster
4	2	2-3/16	1-3/16	(w/o bearing)	RNY-4M0	400	TP6640, TP6740, TP6840, TP7040
			3/4	Roller	RNY-4M7		
		2-7/16	1/2	Precision Ball	RNY-4M5-PBB		
			3/4	Delrin	RNY-4M7-DB		
5	2	2-3/16	1-3/16	(w/o bearing)	RNY-5M0	450	TP6650, TP6750, TP6850, TP7050
			3/4	Roller	RNY-5M7		
		2-7/16	1/2	Precision Ball	RNY-5M5-PBB		
			3/4	Delrin	RNY-5M7-DB		
6	2	2-3/16	1-3/16	(w/o bearing)	RNY-6M0	550	TP6660, TP6760, TP6860, TP7060
			3/4	Roller	RNY-6M7		
		2-7/16	1/2	Precision Ball	RNY-6M5-PBB		
			3/4	Delrin	RNY-6M7-DB		
8	2	2-3/16	1-3/16	(w/o bearing)	RNY-8M0	600	TP6680, TP6780, TP6880, TP7080
			3/4	Roller	RNY-8M7		
		2-7/16	1/2	Precision Ball	RNY-8M5-PBB		
			3/4	Delrin	RNY-8M7-DB		

Note: The load capacity for wheels only may be higher than when used in a caster.

Rubber Wheels

SR/HR Wheels / Capacity up to 280 Lbs.



Features

- Rubber tread is floor protective & help absorbs shock
- Soft rubber tread is 80 Shore A (± 5)
- Hard rubber tread is 75 Shore D (± 5)
- Non-marking Gray soft rubber tread also available
- **Bearings:** Plain bore, Ball Bearings
- **Temperature range:** -20° F to 160° F

Options



Wheel Diameter	Tread Width	Hub Length	Bearing ID	Wheel Bearing	SR Number	SR Load Capacity	HR Number	HR Load Capacity	For Caster
2	13/16	7/8	15/64	Nylon	SR-2A8	80	HR-2A8	90	TP3020, TP8320
	15/16	1	1/4	Nylon	SR-2B1	90	HR-2B1	125	TP3220, TP4020
2-1/2	13/16	7/8	15/64	Nylon	SR-25A8	90	HR-25A8	100	TP3025
	1-1/8	1-3/8	5/16	Nylon	SR-25F2	100	HR-25F2	175	TP4025
3	13/16	7/8	15/64	Nylon	SR-3A8	100	HR-3A8	125	TP3030
	15/16	1	1/4	Nylon	SR-3A2	110	HR-3A2	150	TP3230
	1	1-3/16	5/16	Nylon	SR-3D2	130	HR-3D2	150	TP3630
	1-1/4	1-9/16	3/8	Nylon	SR-3H3	150	HR-3H3	250	TP4030, TP5030
	1-1/4	1-5/8	3/8	Nylon	SRB-3H3	150	HRB-3H3	250	TP4030, TP5030, TP5230
3-1/2	1-1/4	1-7/16	3/8	Nylon	SR-35F3	160	HR-35F3	225	TP5035, TP5235
			1/2	Nylon	SR-35F5	160	HR-35F5	225	TP5035, TP5235
4	1	1-3/16	5/16	Nylon	SR-4D2	145	HR-4D2	160	TP3640
	1-1/4	1-9/16	3/8	Nylon	SR-4H3	170	HR-4H3	250	TP5040
	1-1/4	1-5/8	3/8	Ball	SRB-4H3	170	HRB-4H3	250	TP5040, TP5240
	1-1/4	1-15/16	7/16	Nylon	SR-4L4	200	HR-4L4	300	TP4040
5	1	1-3/16	5/16	Nylon	SR-5D2	150	HR-5D2	170	TP3650
	1-1/4	1-9/16	3/8	Nylon	SR-5H3	200	HR-5H3	280	TP5050
	1-1/4	1-5/8	3/8	Ball	SRB-5H3	200	HRB-5H3	280	TP5050, TP5250

Note: The load capacity for wheels only may be higher than when used in a caster.

Steel Wheels

STL Wheels / Capacity up to 2,500 Lbs.



Features

- Smaller diameter wheels are highly compressed sintered iron
- Larger wheels made from a blend of steel (flexibility) and cast iron (strength)
- Long wearing with high load capacities
- **Bearings:** Delrin, ball, precision ball or roller bearings
- **Temperature range:** -40° F to +500° F

Wheel Diameter	Tread Width	Hub Length	Bearing ID	Wheel Bearing	Wheel Number	Load Capacity	For Caster
2	15/16	1	1/4	Plain	STL-2B1	125	TP3220, TP4020
2-1/2	1-1/8	1-3/8	5/16	Plain	STL-25F2	200	TP4025
3	1-1/4	1-9/16	3/8	Plain	STL-3H3	250	TP4030, TP5130, TP5030, TP5230
4	1-1/4	1-15/16	3/8	Plain	STL-4K3	300	TP5040, TP5140, TP5240, TP5340
			7/16		STL-4K4		
	2	2-3/16	1-3/16	(w/o bearing)	STL-4M0	700	TP6640, TP6640KPL
		2-7/16	3/4	Roller	STL-4M7		
5	2	2-3/16	1-3/16	(w/o bearing)	STL-5M0	1000	TP6650, TP6850
		2-7/16	3/4	Roller	STL-5M7		
6	2	2-3/16	1-3/16	(w/o bearing)	STL-6M0	1200	TP6660, TP6860, TP7060
			2-7/16	3/4	Roller		
	2-1/2	2-3/4	1-15/16	(w/o bearing)	STL-6P0	1600	TP6960, TP7160, TP7260
			1	Roller	STL-6P8		
	3	3-1/4	1-15/16	(w/o bearing)	STL-6R0	2500	TP7560
			1	Roller	STL-6R8		
8	2	2-3/16	1-3/16	(w/o bearing)	STL-8M0	1400	TP6680, TP6880, TP7080
		2-7/16	3/4	Roller	STL-8M7		
	2-1/2	2-3/4	1-15/16	(w/o bearing)	STL-8P0	1600	TP6980, TP7180, TP7280
			1	Roller	STL-8P8		
	3	3-1/4	1-15/16	(w/o bearing)	STL-8R0	2500	TP7580
			1	Roller	STL-8R8		
10	2-1/2	2-3/4	1-15/16	(w/o bearing)	STL-10P0	1800	TP6910, TP7110, TP7210
			1	Roller	STL-10P8		
	3	3-1/4	1-15/16	(w/o bearing)	STL-10R0	2500	TP7510
			1	Roller	STL-10R8		
12	2-1/2	2-3/4	1-15/16	(w/o bearing)	STL-12P0	1800	TP6912, TP7112, TP7212
			1	Roller	STL-12P8		
	3	3-1/4	1-15/16	(w/o bearing)	STL-12R0	2500	TP7512
			1	Roller	STL-12R8		

Note: The load capacity for wheels only may be higher than when used in a caster.

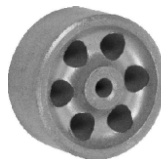

STL-2B1

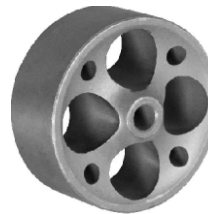

STL-3H3



STL-4K3

Ductile Iron Wheels

SDI Wheels / Capacity up to 6,500 Lbs.



Features

- Ductile iron material has a tensile strength of 40,000 psi
- Extremely rugged with capacities to 6,500 lbs.
- Highly resistant to breakage even under heavy impact loads
- **Bearings:** Delrin, ball, precision ball or roller bearings
- **Temperature range:** -40° F to +800° F

Wheel Diameter	Tread Width	Hub Length	Bearing ID	Wheel Bearing	Wheel Number	Load Capacity	For Caster
4	2	2-3/16	1-3/16	(w/o bearing)	SDI-4M0	1500	TP6640, TP6840, TP7040
		2-7/16	3/4	Roller	SDI-4M7		
5	2	2-3/16	1-3/16	(w/o bearing)	SDI-5M0	1600	TP6650, TP6850, TP7050
		2-7/16	3/4	Roller	SDI-5M7		
6	2	2-3/16	1-3/16	(w/o bearing)	SDI-6M0	1900	TP6660, TP6860, TP7060
		2-7/16	3/4	Roller	SDI-6M7		
	2-1/2	2-3/4	1-15/16	(w/o bearing)	SDI-6P0	3400	TP6960, TP7160, TP7260
		2-7/8	1	Roller	SDI-6P8		
	3	3-1/4	1-15/16	(w/o bearing)	SDI-6R0	4800	TP7560
		3-3/8	1	Roller	SDI-6R8		
8	2	2-3/16	1-3/16	(w/o bearing)	SDI-8M0	2000	TP6680, TP6880, TP7080
		2-7/16	3/4	Roller	SDI-8M7		
	2-1/2	2-3/4	1-15/16	(w/o bearing)	SDI-8P0	4000	TP6980, TP7180, TP7280
		2-7/8	1	Roller	SDI-8P8		
	3	3-1/4	1-15/16	(w/o bearing)	SDI-8R0	5600	TP7580
		3-3/8	1	Roller	SDI-8R8		
10	2-1/2	2-3/4	1-15/16	(w/o bearing)	SDI-10P0	4500	TP6910, TP7110, TP7210
		2-7/8	1	Roller	SDI-10P8		
	3	3-1/4	1-15/16	(w/o bearing)	SDI-10R0	6000	TP7510
		3-3/8	1	Roller	SDI-10R8		
12	3	3-1/4	1-15/16	(w/o bearing)	SDI-12R0	6500	TP7512
		3-3/8	1	Roller	SDI-12R8		

Note: The load capacity for wheels only may be higher than when used in a caster.

V-Groove Steel Wheels

VGR Wheels / Capacity up to 1,000 Lbs.

VGR Wheels



Features

- Machined groove in wheel includes a bottom groove for load equalization
- For use on tracks, or flat surfaces
- Long wearing with high load capacities
- **Bearings:** Delrin, ball, precision ball or roller bearings
- **Temperature range:** -40° F to +500° F

Wheel Diameter	Tread Width	Hub Length	Bearing ID	Wheel Bearing	Wheel Number	Load Capacity	For Caster
4	1-1/2	1-7/8	1-3/16	(w/o bearing)	VGR-4K0	350	TP6240, TP6440
			3/4	Roller	VGR-4K7		
	2	2-3/16	1-3/16	(w/o bearing)	VGR-4M0	700	TP6640, TP6740, TP7040
			3/4	Roller	VGR-4M7-F		
5	2	2-3/16	1-3/16	(w/o bearing)	VGR-5M0	900	TP6650, TP6750, TP6850, TP7050
			3/4	Roller	VGR-5M7		
6	2	2-3/16	1-3/16	(w/o bearing)	VGR-6M0	1000	TP6660, TP6760, TP6860, TP7060
			3/4	Roller	VGR-6M7-F		
	2-1/2	2-3/4	1-15/16	(w/o bearing)	VGR-6P0	1600	TP6960, TP7160, TP7260
			1	Roller	VGR-6P8		
	3	3-1/4	1-15/16	(w/o bearing)	VGR-6R0	2500	TP7560, TP7260KPL, TP7560KPL
			1	Roller	VGR-6R8		
8	2-1/2	2-3/4	1-15/16	(w/o bearing)	VGR-8P0	1800	TP6980, TP7180, TP7280
			1	Roller	VGR-8P8		
	3	3-1/4	1-15/16	(w/o bearing)	VGR-8R0	2500	TP7580, TP7280KPL, TP7580KPL
			1	Roller	VGR-8R8		

Note: The load capacity for wheels only may be higher than when used in a caster.



VGR-4K0



VGR-6M0



VGN-4M0

Axles and Nuts

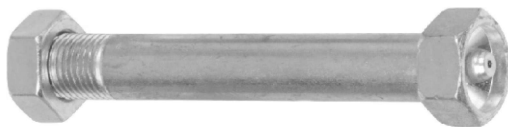

Axle Diameter	Axle Length	Part Number	Note	For Series
Plain Axles and Nuts				
1/4	1-1/2	AN25-150		TP3200, TP3230, TP4020
5/16	1-13/16	AN31-184		TP3600
	1-7/8	AN31-188		TP4025
	1-15/16	AN31-191		TP3600-TLB
	2	AN31-200		TP4025-SLB
	2-1/8	AN31-213		TP8100
3/8	2-1/8	AN38-213		TP5200, TP8100
	2-1/4	AN38-225		TP4030, TP5000, TP5200
	2-1/4	AN38-225-SS	Stainless	TP5100
	2-7/16	AN38-244		TP5000-TLB, TP5200-TLB
	2-5/8	AN38-263		TP8030
7/16	2-13/16	AN44-281		TP4040

Zerk Axles and Nuts				
3/8	2-1/4	AZ38-225		TP5000, TP5200
		AZ38-225-SS	Stainless	TP5100
1/2	2-7/8	AZ50-288		TP6200, TP6400
	3-3/8	AZ50-338		TP6600, TP6800, TP7000
		AZ50-338-SS	Stainless	TP6700
7/16	2-13/16	AN44-281		TP4040
3/4	4-1/4	AZ75-425		TP6900, TP7100, TP7200
	4-3/4	AZ75-475		TP7500, TP7200KPL, TP7500KPL
	4-29/32	AZ75-490		WB A/N for TP7200KPL. TP7500KPL

Note: The load capacity for wheels only may be higher than when used in a caster.

Brakes

Features

- **SLB** - Side Lock Brakes use side-compression to lock the wheel
- **TLB** - Top Lock Brakes use pedal/lever system to brake the caster
- **SWB** - Swivel Wheel Brakes lock down both the swivel and wheel
- **FLB** - Front Lock Brakes directly contact tread to lock wheel
- **CLB** - Cam Lock Brakes work on both swivel and rigid TP6600 series casters

For Series	Axle Size	SLB	TLB	SWB	FLB	CLB
TP3000	1/4		TLB-3020		FLB-3020	
			TLB-3030			
TP3200	1/4		TLB-3220			
			TLB-3230			
TP3600	5/16		TLB-3630			
			TLB-3640			
			TLB-3650			
TP4000	1/4	SLB-4020				
	5/16	SLB-4025				
	3/8	SLB-4030				
	7/16	SLB-4040				
TP5000	3/8		TLB-5030	SWB-5030		
			TLB-5035	SWB-5035		
			TLB-5040	SWB-5040		
			TLB-5050	SWB-5050		
TP5100	3/8		TLB-5130			
			TLB-5140			
			TLB-5150			
TP5200	3/8		TLB-5030		FLB-5230	
			TLB-5035		FLB-5235	
			TLB-5040		FLB-5240	
			TLB-5050		FLB-5250	
TP6200 TP6400	1/2		TLB-6240			
			TLB-6250			
			TLB-6260			
TP6600	1/2		TLB-6640		FLB-6640	CLB-6600
			TLB-6650		FLB-6650	
			TLB-6660		FLB-6660	
			TLB-6680		FLB-6680	
TP6700	1/2		TLB-6740			
			TLB-6750			
			TLB-6760			
			TLB-6780			
TP6800	1/2		TLB-6840			CLB-6600
			TLB-6850			
			TLB-6860			
			TLB-6880			

- * **SLB** : Side Lock Brake
- * **SWB** : Swivel and Wheel Brake (Total Lock)
- * **CLB** : Cam Lock Brake

- * **TLB** : Top Lock Brake
- * **FLB** : Front Lock Brake

• TLB: Top Lock Brake



• SWB-5000 Series



• FLB-5200 Series



• FLB-6600 Series



Brakes

Bearings

Features

- Plain Bearings are really no bearing at all - the wheel rides directly on the axle
- Delrin is an acetal resin molded into a flange-type bearing and requires no lubrication
- Ball Bearings feature a one-piece stamped construction outer raceway, cold-rolled and formed, machined and hardened with bearings shielded and pre-greased
- Precision Ball Bearings feature a sealed, hardened inner and outer raceway, and hardened steel balls, press-fitted into the hub for high-load and higher speed capabilities
- Roller Bearings have a split-sleeve hardened spring steel outer race combined with a hardened roller and cage assembly for higher load capacities and smoother rolling under heavy conditions

Bearing ID	Bearing OD	Length	Part Number	Note
Delrin Bearings				
1/2	1-3/16	0.69"	BD50-069	TP6400, 6600, 6700, 6800
3/4	1-3/16	0.69"	BD75-069	TP6400, 6600, 6700, 6800
Roller Bearings				
1/2	1-3/16	1-3/8	BR50-138	TP5000, 5200, 5400
5/8	1-3/16	1-3/4	BR63-175	TP8030
		1-7/8	BR63-188	
3/4	1-3/16	1-3/8	BR75-138	TP6200, 6400
		1-7/8	BR75-188	TP6600, 6800, 7000
			BR75-188-SS	Stainless Steel
1	1-15/16	2-1/2	BR100-250	TP6900, 7100, 7200
		3	BR100-300	TP7500
1-1/4	1-15/16	3	BR125-300	
Ball Bearings				
5/16	1-1/8		BB31-118	PLY
3/8	1-1/8		BB38-118	PLY
1/2	1-1/8		BB50-118	PLY
Precision Ball Bearings				
1/2	1-3/16		PBB50-119	TP6600
			PBB50-119-SS	TP6700/Stainless Steel
	1-3/8		PBB50-138PNU	PNU, AFR
5/8	1-3/8		PBB63-138PNU	PNU, AFR
3/4	1-3/8		PBB75-138PNU	PNU, AFR

• Delrin Bearing



• Ball Bearing



• Precision Ball Bearing



• Roller Bearing



Spanner Bushings



Features

- Adds extra stability between axle and bearing
- Available in delrin and steel
- Metal bushings are oil impregnated

Bushing ID	Bushing OD	Length	Part Number	Note
Delrin Bushings				
1/2	3/4	1-7/8	SD75-188D	TP6200, 6400
		2-7/16	SD75-244D	TP6600, 6700, 6800,
Metal/Steel				
5/16	3/8	1-1/2	SM38-150	
		1-5/8	SM38-163	
3/8	1/2	1-1/2	SM50-150	TP5000, 5200
		1-11/16	SM50-169D	Cross-Drilled
		1-5/8	SM50-169-SS	TP5100 / Stainless Steel
1/2	3/4	1-7/8	SM75-188D	TP6200, 6400
		2-7/16	SM75-244D	TP6600, 6800, 7000
			SM75-244-SS	TP6700 / Stainless Steel
3/4	1	2-7/8	SM100-288D	TP6900, 7100, 7200
		3-3/8	SM100-338D	TP7500

Floor Truck Locks



Features

- Helps prevent carts from unintentionally rolling away
- Step on pedal to lock, release using "handle bars"
- Rubber pad protects floor
- Four popular heights to match your equipment needs

Size	Lowered Height	Extended Height	Part Number
4	5-1/8	5-15/16	FTL-400
5	5-3/4	6-3/4	FTL-500
6	6-3/4	7-3/4	FTL-600
8	8-7/16	9-3/4	FTL-800

Spanner Bushings

Corner Bumpers



Features

- 1" thick with 3" long sides
- 5/16" mounting holes
- Non-marking, steel-reinforced
- Available in black or gray

Type	Size	Note	Part Number
Corner Bumper	3 x 3 x 1	Two 5/16 mounting holes in each side.	CB-GRAY
			CB-BLACK

Caster Dock

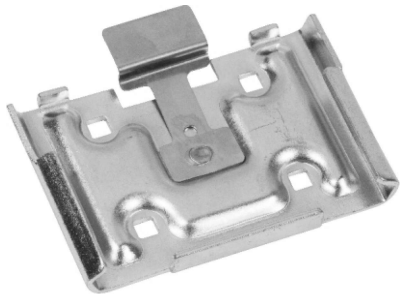

Features

- Fits 4 x 4-1/2 top plates
- Used for quickly changing out casters on carts
- Unplated steel
- Includes nut & bolt for securing caster

	Size	Part Number
For use with Top Plate	2-1/2 x 3-3/4	CD-5000
Bolt Hole Spacing	1-1/2 x 2	
Attaching Bolt Size	1/4	
For use with Top Plate	4 x 4-1/2	CD-6600
Bolt Hole Spacing	2-5/8 x 3-5/8 slotted to 3 x 3	
Attaching Bolt Size	3/8	

Engineering Note

A series of horizontal dotted lines for writing notes.



TrioPines
C A S T E R S

SALES OFFICES & WAREHOUSES

LOS ANGELES - CORPORATE HEADQUARTERS

Trio Pines (USA), Inc.

6655 Knott Ave. Buena Park, CA 90620

Tel: 714-523-5800 / Fax: 714-523-5900

800-468-6987 Toll-free in the U.S. and Canada

CHICAGO

Trio Pines (USA), Inc.

1125 Jansen Farm Drive, Elgin, IL 60123

Tel: 847-695-9191 / Fax: 847-695-0582

800-647-9991 Toll-free in the U.S. and Canada

DALLAS

Trio Pines (USA), Inc.

9151 King Arthur Dr. Dallas, TX 75247

Tel: 214-638-4676 / Fax: 214-631-0696

800-608-4676 Toll-free in the U.S. and Canada

KOREA

Sam Song Caster Co. Ltd.

Incheon, Korea

Tel: 032-527-2150/6 / Fax: 032-524-2652

CHINA

Trio Pines Caster Co, Inc.

China



Follow us on
facebook

<http://facebook.com/triopines>



www.TrioPines.com